

ARBI

RACCOLTA DUEMILA19

ARBI
BATHROOM

RACCOLTA
LAVABI
VASCHE
SPECCHIERE
FARETTI



WASHBASINS
CONSOLE
TOPS

VASQUES
CONSOLE
PLAN DE TOILETTE

LAVABI
CONSOLLE
PIANI TOP



Quadro - ceramica/ceramic/c eramique

Lavabo ad incasso (con foro troppo pieno)
Recessed undercounter washbasin (with overflow)
Vasque encastr ee (avec trop-plein)

Ceramica / ceramic / c eramique

Dimensioni L 52,5 x P 35 x H 17,5 cm / full sizes W 52,5 x D 35 x H 17,5 cm / dimensions L 52,5 x P 35 x H 17,5 cm

Basi portal. min. L 70 cm / Washbasin units min. W 70 cm / Base lav. min. L 70 cm

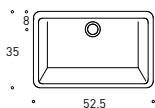

Art. **5542** - P. 347



Nice 60 - ceramica/ceramic/c eramique

Lavabo sopra piano (senza foro troppo pieno)
OVERTOP washbasin (without overflow)
Vasque ENCASTR EE (sans trop-plein)

Ceramica / ceramic / c eramique

Dimensioni L 60 x P 40 x H 5/12,5 cm / full sizes W 60 x D 40 x H 5/12,5 cm / dimensions L 60 x P 40 x H 5/12,5 cm

Basi portal. min. L 70 cm / washbasin units min. W 70 cm / base lav. min. L 70 cm

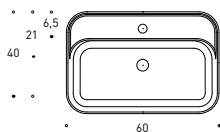

Art. **A026** - P. 347



Pretty 60 - ceramica/ceramic/c eramique

Lavabo semincasso (senza foro troppo pieno)
Semi-recessed washbasin (without overflow)
Vasque semi-encastr ee (sans trop-plein)

Ceramica / ceramic / c eramique

Dimensioni L 60 x P 40 x H 5/14 cm / full sizes W 60 x D 40 x H 5/14 cm / dimensions L 60 x P 40 x H 5/14 cm

Basi portal. min. L 70 cm / washbasin units min. W 70 cm / base lav. min. L 70 cm

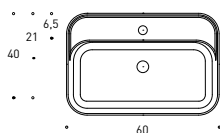

Art. **A041** - P. 347



Wonder 60 - ceramica/ceramic/c eramique

Lavabo TUTTO FUORI (con foro troppo pieno)
TUTTO FUORI washbasin (with overflow)
Vasque TUTTO FUORI (avec trop-plein)

Ceramica / ceramic / c eramique

Dimensioni L 60 x P 48 x H 12 cm / full sizes W 60 x D 48 x H 12 cm / dimensions L 60 x P 48 x H 12 cm

Basi portal. min. L 70 cm / Washbasin units min. W 70 cm / Base lav. min. L 70 cm

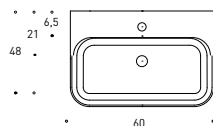

Art. **A342** - P. 348

Beauty 40 - ceramica/ceramic/c ramique

Lavabo TUTTO FUORI (senza foro troppo pieno)
TUTTO FUORI washbasin (without overflow)
Vasque TUTTO FUORI (sans trop-plein)

Ceramica / ceramic / c ramique

Dimensioni L 40 x P 36,5 x H 12 cm / full sizes W 40 x D 36,5 x H 12 cm / dimensions L 40 x P 36,5 x H 12 cm

Basi portal. min. L 50 cm / Washbasin units min. W 50 cm / Base lav. min. L 50 cm

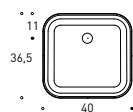

Art. **A023** - P. 348

Beauty 60 - ceramica/ceramic/c ramique

Lavabo TUTTO FUORI (senza foro troppo pieno)
TUTTO FUORI washbasin (without overflow)
Vasque TUTTO FUORI (sans trop-plein)

Ceramica / ceramic / c ramique

Dimensioni L 60 x P 38 x H 12 cm / full sizes W 60 x D 38 x H 12 cm / dimensions L 60 x P 38 x H 12 cm

Basi portal. min. L 70 cm / Washbasin units min. W 70 cm / Base lav. min. L 70 cm

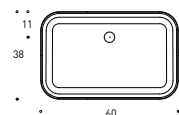

Art. **A024** - P. 348

Cuir 55 - ceramica/ceramic/c ramique

Lavabo TUTTO FUORI (senza foro troppo pieno) - comprensivo di piletta Stop & Go in ceramica
TUTTO FUORI washbasin (without overflow) - pop-up ceramic plug included
Vasque TUTTO FUORI (sans trop-plein) - bonde Stop & Go en c ramique inclus

Ceramica / ceramic / c ramique

Dimensioni L 55 x P 40 x H 17 cm / full sizes W 55 x D 40 x H 17 cm / dimensions L 55 x P 40 x H 17 cm

Basi portal. min. L 70 cm / Washbasin units min. W 70 cm / Base lav. min. L 70 cm

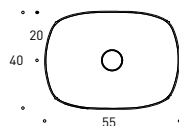

Art. **A185** LUCIDO / GLOSSY / LUCIDO - P. 347

Art. **A485** OPACO / MATT / MAT - P. 347



MENEGHELLO PAOLELLI ASSOCIATI

Cuir 63 - ceramica/ceramic/c ramique

Lavabo TUTTO FUORI (senza foro troppo pieno) - comprensivo di piletta Stop & Go in ceramica
TUTTO FUORI washbasin (without overflow) - pop-up ceramic plug included
Vasque TUTTO FUORI (sans trop-plein) - bonde Stop & Go en c ramique inclus

Ceramica / ceramic / c ramique

Dimensioni L 63 x P 39 x H 15 cm / full sizes W 63 x D 39 x H 15 cm / dimensions L 63 x P 39 x H 15 cm

Basi portal. min. L 70 cm / Washbasin units min. W 70 cm / Base lav. min. L 70 cm

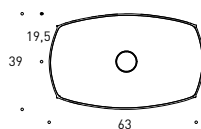

Art. **A186** LUCIDO / GLOSSY / LUCIDO - P. 347

Art. **A486** OPACO / MATT / MAT - P. 347



MENEGHELLO PAOLELLI ASSOCIATI





Panier 42 - ceramica/ceramic/c ramique

Lavabo TUTTO FUORI (senza foro troppo pieno) - comprensivo di piletta Stop & Go in ceramica
 TUTTO FUORI washbasin (without overflow) - pop-up ceramic plug included
 Vasque TUTTO FUORI (sans trop-plein) - bonde Stop & Go en c ramique inclus

Ceramica / ceramic / c ramique

Dimensioni L 42 x P 42 x H 14 cm / full sizes W 42 x D 42 x H 14 cm / dimensions L 42 x P 42 x H 14 cm

Basi portal. min. L 50 cm / Washbasin units min. W 50 cm / Base lav. min. L 50 cm

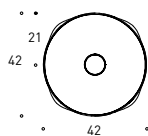

Art. **A183** LUCIDO / GLOSSY / LUCIDO - P. 347
 Art. **A483** OPACO / MATT / MAT - P. 347



Panier 56 - ceramica/ceramic/c ramique

Lavabo TUTTO FUORI (senza foro troppo pieno) - comprensivo di piletta Stop & Go in ceramica
 TUTTO FUORI washbasin (without overflow) - pop-up ceramic plug included
 Vasque TUTTO FUORI (sans trop-plein) - bonde Stop & Go en c ramique inclus

Ceramica / ceramic / c ramique

Dimensioni L 56 x P 39 x H 14 cm / full sizes W 56 x D 39 x H 14 cm / dimensions L 56 x P 39 x H 14 cm

Basi portal. min. L 60 cm / Washbasin units min. W 60 cm / Base lav. min. L 60 cm

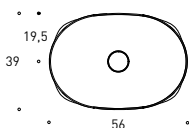

Art. **A184** LUCIDO / GLOSSY / LUCIDO - P. 347
 Art. **A484** OPACO / MATT / MAT - P. 347



Up - ceramica/ceramic/c ramique

Lavabo TUTTO FUORI (senza foro troppo pieno)
 TUTTO FUORI washbasin (without overflow)
 Vasque TUTTO FUORI (sans trop-plein)

Ceramica / ceramic / c ramique

Dimensioni L 42 x P 42 x H 16 cm / full sizes W 42 x D 42 x H 16 cm / dimensions L 42 x P 42 x H 16 cm

Basi portal. min. L 50 cm / Washbasin units min. W 50 cm / Base lav. min. L 50 cm

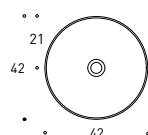

Art. **A290** - P. 349



Fine 60 - ceramica/ceramic/c ramique

Lavabo TUTTO FUORI (senza foro troppo pieno)
 TUTTO FUORI washbasin (without overflow)
 Vasque TUTTO FUORI (sans trop-plein)

Ceramica / ceramic / c ramique

Dimensioni L 60 x P 38,5 x H 14 cm / full sizes W 60 x D 38,5 x H 14 cm / dimensions L 60 x P 38,5 x H 14 cm

Basi portal. min. L 60 cm / Washbasin units min. W 60 cm / Base lav. min. L 70 cm

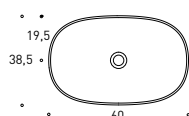

Art. **A289** - P. 348



Ghost - ceramica/ceramic/c eramique

Lavabo TUTTO FUORI (senza foro troppo pieno)
TUTTO FUORI washbasin (without overflow)
Vasque TUTTO FUORI (sans trop-plein)

Ceramica / ceramic / c eramique

Dimensioni L 55,5 x P 35,5 x H 15 cm / full sizes W 55,5 x D 35,5 x H 15 cm / dimensions L 55,5 x P 35,5 x H 15 cm

Basi portal. min. L 60 cm / Washbasin units min. W 60 cm / Base lav. min. L 60 cm

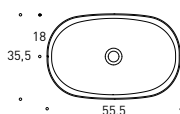

Art. **A288** - P. 348



Ciotolina - ceramica/ceramic/c eramique

Lavabo TUTTO FUORI (senza foro troppo pieno)
TUTTO FUORI washbasin (without overflow)
Vasque TUTTO FUORI (sans trop-plein)

Ceramica / ceramic / c eramique

Dimensioni L 40 x P 40 x H 12,5 cm / full sizes W 40 x D 40 x H 12,5 cm / dimensions L 40 x P 40 x H 12,5 cm

Basi portal. min. L 50 cm / Washbasin units min. W 50 cm / Base lav. min. L 50 cm

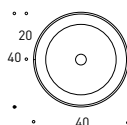

Art. **A344** - P. 348



Soffice Out - ceramica/ceramic/c eramique

Lavabo TUTTO FUORI (senza foro troppo pieno)
TUTTO FUORI washbasin (without overflow)
Vasque TUTTO FUORI (sans trop-plein)

Ceramica / ceramic / c eramique

Dimensioni L 59,5 x P 42 x H 17 cm / full sizes W 59,5 x D 42 x H 17 cm / dimensions L 59,5 x P 42 x H 17 cm

Basi portal. min. L 50 cm / Washbasin units min. W 50 cm / Base lav. min. L 50 cm

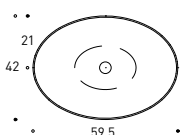

Art. **A451** - P. 348



Soffice In - ceramica/ceramic/c eramique

Lavabo TUTTO FUORI (senza foro troppo pieno)
TUTTO FUORI washbasin (without overflow)
Vasque TUTTO FUORI (sans trop-plein)

Ceramica / ceramic / c eramique

Dimensioni L 60,5 x P 43,5 x H 17 cm / full sizes W 60,5 x D 43,5 x H 17 cm / dimensions L 60,5 x P 43,5 x H 17 cm

Basi portal. min. L 50 cm / Washbasin units min. W 50 cm / Base lav. min. L 50 cm

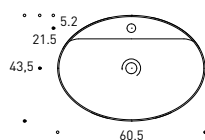

Art. **A452** - P. 348





LAVABI / BASINS / VASQUES



Seed Alto - ceramica/ceramic/c ramique

Lavabo TUTTO FUORI (senza foro troppo pieno) - comprensivo di piletta Stop & Go in ceramica
 TUTTO FUORI washbasin (without overflow) - pop-up ceramic plug included
 Vasque TUTTO FUORI (sans trop-plein) - bonde Stop & Go en c ramique inclus

Ceramica / ceramic / c ramique

Dimensioni L 40 x P 40 x H 18 cm / full sizes W 40 x D 40 x H 18 cm / dimensions L 40 x P 40 x H 18 cm

Basi portal. min. L 50 cm / Washbasin units min. W 50 cm / Base lav. min. L 50 cm

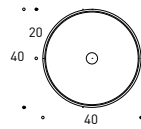

Art. **A347** - P. 349



Seed 45 - ceramica/ceramic/c ramique

Lavabo TUTTO FUORI (senza foro troppo pieno) - comprensivo di piletta Stop & Go in ceramica
 TUTTO FUORI washbasin (without overflow) - pop-up ceramic plug included
 Vasque TUTTO FUORI (sans trop-plein) - bonde Stop & Go en c ramique inclus

Ceramica / ceramic / c ramique

Dimensioni L 45 x P 40 x H 15 cm / full sizes W 45 x D 40 x H 15 cm / dimensions L 45 x P 40 x H 15 cm

Basi portal. min. L 50 cm / Washbasin units min. W 50 cm / Base lav. min. L 50 cm

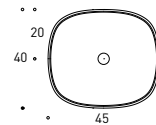

Art. **A349** - P. 349



Seed 55 - ceramica/ceramic/c ramique

Lavabo TUTTO FUORI (senza foro troppo pieno) - comprensivo di piletta Stop & Go in ceramica
 TUTTO FUORI washbasin (without overflow) - pop-up ceramic plug included
 Vasque TUTTO FUORI (sans trop-plein) - bonde Stop & Go en c ramique inclus

Ceramica / ceramic / c ramique

Dimensioni L 55 x P 42 x H 15 cm / full sizes W 55 x D 42 x H 15 cm / dimensions L 55 x P 42 x H 15 cm

Basi portal. min. L 60 cm / Washbasin units min. W 60 cm / Base lav. min. L 60 cm

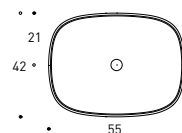

Art. **A350** - P. 349



Delta 60 - ceramica/ceramic/c ramique

Lavabo TUTTO FUORI (con foro troppo pieno)
 TUTTO FUORI washbasin (with overflow)
 Vasque TUTTO FUORI (avec trop-plein)

Ceramica / ceramic / c ramique

Dimensioni L 60 x P 46 x H 12,5 cm / full sizes W 60 x D 46 x H 12,5 cm / dimensions L 60 x P 46 x H 12,5 cm

Basi portal. min. L 70 cm / Washbasin units min. W 70 cm / Base lav. min. L 70 cm

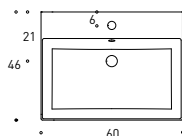

Art. **A353** - P. 349



Omega 60 - ceramica/ceramic/c eramique

Lavabo TUTTO FUORI (senza foro troppo pieno)
TUTTO FUORI washbasin (without overflow)
Vasque TUTTO FUORI (sans trop-plein)

Ceramica / ceramic / c eramique

Dimensioni L 60 x P 38 x H 12 cm / full sizes W 60 x D 38 x H 12 cm / dimensions L 60 x P 38 x H 12 cm

Basi portal. min. L 60 cm / Washbasin units min. W 60 cm / Base lav. min. L 60 cm

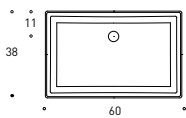

Art. **A345** - P. 349



Vela - tekno

Lavabo TUTTO FUORI (senza foro troppo pieno)
TUTTO FUORI washbasin (without overflow)
Vasque TUTTO FUORI (sans trop-plein)

Tekno / tekno / tekno

Dimensioni L 71 x P 34 x H 17/13,5 cm / full sizes W 71 x D 34 x H 17/13,5 cm / dimensions L 71 x P 34 x H 17/13,5 cm

Basi portal. min. L 50 cm / Washbasin units min. W 50 cm / Base lav. min. L 50 cm

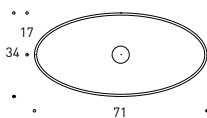

Art. **A600** - P. 351



Lady 55 - tekno

Lavabo TUTTO FUORI (senza foro troppo pieno)
TUTTO FUORI washbasin (without overflow)
Vasque TUTTO FUORI (sans trop-plein)

Tekno / tekno / tekno

Dimensioni L 55 x P 48 x H 12 cm / full sizes W 55 x D 48 x H 12 cm / dimensions L 5 x P 48 x H 12 cm

Basi portal. min. L 60 cm / Washbasin units min. W 50 cm / Base lav. min. L 50 cm

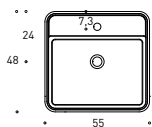

Art. **A355** - P. 351



Lady 70 - tekno

Lavabo TUTTO FUORI (senza foro troppo pieno)
TUTTO FUORI washbasin (without overflow)
Vasque TUTTO FUORI (sans trop-plein)

Tekno / tekno / tekno

Dimensioni L 70 x P 48 x H 12 cm / full sizes W 70 x D 48 x H 12 cm / dimensions L 70 x P 48 x H 12 cm

Basi portal. min. L 85 cm / Washbasin units min. W 85 cm / Base lav. min. L 85 cm

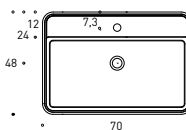

Art. **A356** - P. 351









Miss 60 - tekno

Lavabo TUTTO FUORI (senza foro troppo pieno) comprensivo di tappo copripiletta /
TUTTO FUORI washbasin (without overflow) including cover in tekno /
Vasque TUTTO FUORI (sans trop-plein) avec bouchon en tekno.

Tekno / tekno / tekno

Dimensioni L 61 x P 48,5 x H 12 cm / full sizes W 61 x D 48,5 x H 12 cm / dimensions L 61 x P 48,5 x H 12 cm

Basi portal. min. L 70 cm / Washbasin units min. W 70 cm / Base lav. min. L 70 cm

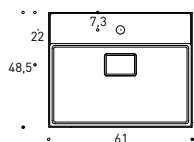

Art. **A357** - P. 350



Miss 80 - tekno

Lavabo TUTTO FUORI (senza foro troppo pieno) comprensivo di tappo copripiletta /
TUTTO FUORI washbasin (without overflow) including cover in tekno /
Vasque TUTTO FUORI (sans trop-plein) avec bouchon en tekno.

Tekno / tekno / tekno

Dimensioni L 81 x P 48,5 x H 12 cm / full sizes W 81 x D 48,5 x H 12 cm / dimensions L 81 x P 48,5 x H 12 cm

Basi portal. min. L 85 cm / Washbasin units min. W 85 cm / Base lav. min. L 85 cm

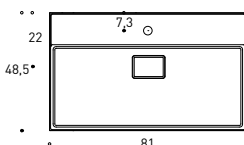

Art. **A358** - P. 350



Miss 100 - tekno

Lavabo TUTTO FUORI (senza foro troppo pieno) comprensivo di tappo copripiletta /
TUTTO FUORI washbasin (without overflow) including cover in tekno /
Vasque TUTTO FUORI (sans trop-plein) avec bouchon en tekno.

Tekno / tekno / tekno

Dimensioni L 101 x P 48,5 x H 12 cm / full sizes W 101 x D 48,5 x H 12 cm / dimensions L 101 x P 48,5 x H 12 cm

Basi portal. min. L 105 cm / Washbasin units min. W 105 cm / Base lav. min. L 105 cm

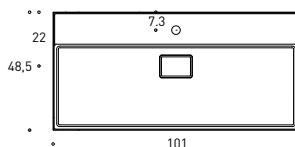

Art. **A359** - P. 350



Belt Inc - tekno

Lavabo INCASSO SOPRAPIANO (senza foro troppo pieno) comprensivo di piletta Stop & Go in tekno /
OVERTOP washbasin (without overflow). Pop-up tekno plug included /
Vasque ENCASTRÉ (sans trop-plein) - bonde Stop & Go en tekno inclus.

Tekno / tekno / tekno

Dimensioni L 55 x P 38 x H 3,7/13 cm / full sizes W 55 x D 38 x H 3,7/13 cm / dimensions L 55 x P 38 x H 3,7/13 cm

Basi portal. min. L 70 cm / Washbasin units min. W 70 cm / Base lav. min. L 70 cm

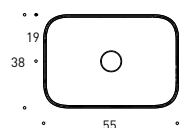

Art. **A191** - P. 350



MENEGHELLO PAOLELLI
ASSOCIATI



Belt Q - tekno

Lavabo TUTTO FUORI (senza foro troppo pieno) comprensivo di piletta Stop & Go in tekno/
TUTTO FUORI washbasin (without overflow). Pop-up tekno plug included /
Vasque TUTTO FUORI (sans trop-plein) - bonde Stop & Go en tekno inclus.

Tekno / tekno / tekno

Dimensioni L 40 x P 40 x H 15 cm / full sizes W 40 x D 40 x H 15 cm / dimensions L 40 x P 40 x H 15 cm

Basi portal. min. L 50 cm / Washbasin units min. W 50 cm / Base lav. min. L 50 cm

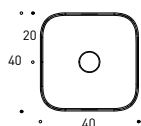

Art. **A189** - P. 350



MENEGHELLO PAOLELLI
ASSOCIATI



Belt 40 - tekno

Lavabo TUTTO FUORI (senza foro troppo pieno) comprensivo di piletta Stop & Go in tekno/
TUTTO FUORI washbasin (without overflow). Pop-up tekno plug included /
Vasque TUTTO FUORI (sans trop-plein) - bonde Stop & Go en tekno inclus.

Tekno / tekno / tekno

Dimensioni L 40 x P 40 x H 17 cm / full sizes W 40 x D 40 x H 17 cm / dimensions L 40 x P 40 x H 17 cm

Basi portal. min. L 50 cm / Washbasin units min. W 50 cm / Base lav. min. L 50 cm

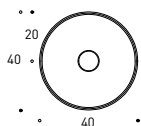

Art. **A187** - P. 350



MENEGHELLO PAOLELLI
ASSOCIATI



Belt 55 - tekno

Lavabo TUTTO FUORI (senza foro troppo pieno) comprensivo di piletta Stop & Go in tekno/
TUTTO FUORI washbasin (without overflow). Pop-up tekno plug included /
Vasque TUTTO FUORI (sans trop-plein) - bonde Stop & Go en tekno inclus.

Tekno / tekno / tekno

Dimensioni L 55 x P 38 x H 13 cm / full sizes W 55 x D 38 x H 13 cm / dimensions L 55 x P 38 x H 13 cm

Basi portal. min. L 60 cm / Washbasin units min. W 60 cm / Base lav. min. L 60 cm

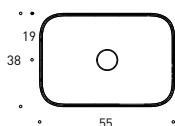

Art. **A190** - P. 350



MENEGHELLO PAOLELLI
ASSOCIATI



Belt 60 - tekno

Lavabo TUTTO FUORI (senza foro troppo pieno) comprensivo di piletta Stop & Go in tekno/
TUTTO FUORI washbasin (without overflow). Pop-up tekno plug included /
Vasque TUTTO FUORI (sans trop-plein) - bonde Stop & Go en tekno inclus.

Tekno / tekno / tekno

Dimensioni L 60 x P 40 x H 15 cm / full sizes W 60 x D 40 x H 15 cm / dimensions L 60 x P 40 x H 15 cm

Basi portal. min. L 70 cm / Washbasin units min. W 70 cm / Base lav. min. L 70 cm

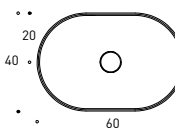

Art. **A188** - P. 350



MENEGHELLO PAOLELLI
ASSOCIATI



King - tekno

Lavabo TUTTO FUORI (senza foro troppo pieno)
TUTTO FUORI washbasin (without overflow)
Vasque TUTTO FUORI (sans trop-plein)

Tekno / tekno / tekno

Dimensioni L 60 x P 40 x H 19,5 cm / full sizes W 60 x D 40 x H 19,5 cm / dimensions L 60 x P 40 x H 19,5 cm

Basi portal. min. L 50 cm / Washbasin units min. W 50 cm / Base lav. min. L 50 cm

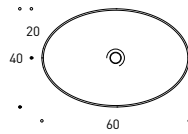

Art. **A361** - P. 351



Semisfera - tekno

Lavabo TUTTO FUORI (senza foro troppo pieno)
TUTTO FUORI washbasin (without overflow)
Vasque TUTTO FUORI (sans trop-plein)

Tekno / tekno / tekno

Dimensioni L 42 x P 42 x H 19 cm / full sizes W 42 x D 42 x H 19 cm / dimensions L 42 x P 42 x H 19 cm

Basi portal. min. L 50 cm / Washbasin units min. W 50 cm / Base lav. min. L 50 cm

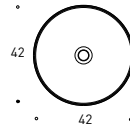

Art. **A360** - P. 351

Bart

ceramica/ceramic/c eramique



Bart 62

Consolle H 7 cm (con foro troppo pieno)
H 7 cm console (with overflow)
Consolle H 7 cm (avec trop-plein)

Ceramica / ceramic / c eramique

Dimensioni L 62 x P 41,5 x H 7 cm / full sizes W 62 x D 41,5 x H 7 cm / dimensions L 62 x P 41,5 x H 7 cm

Per basi portavavabo L 60 x P 37 cm / for washbasin units W 60 x D 37 cm / base lavabo L 60 x P 37 cm

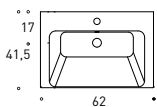

Art. **A441** - P. 358



Bart 72

Consolle H 7 cm (con foro troppo pieno)
 H 7 cm console (with overflow)
 Consolle H 7 cm (avec trop-plein)

Ceramica / ceramic / céramique

Dimensioni L 72 x P 41,5 x H 7 cm / full sizes W 72 x D 41,5 x H 7 cm / dimensions L 72 x P 41,5 x H 7 cm

Per basi portalavabo L 70 x P 37 cm / for washbasin units W 70 x D 37 cm / base lavabo L 70 x P 37 cm

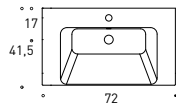

Art. **A442** - P. 358



Bart 87

Consolle H 7 cm (con foro troppo pieno)
 H 7 cm console (with overflow)
 Consolle H 7 cm (avec trop-plein)

Ceramica / ceramic / céramique

Dimensioni L 87 x P 41,5 x H 7 cm / full sizes W 87 x D 41,5 x H 7 cm / dimensions L 87 x P 41,5 x H 7 cm

Per basi portalavabo L 85 x P 37 cm / for washbasin units W 85 x D 37 cm / base lavabo L 85 x P 37 cm

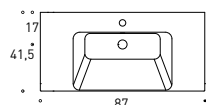

Art. **A443** - P. 358



Bart 97

Consolle H 7 cm (con foro troppo pieno)
 H 7 cm console (with overflow)
 Consolle H 7 cm (avec trop-plein)

Ceramica / ceramic / céramique

Dimensioni L 97 x P 41,5 x H 7 cm / full sizes W 97 x D 41,5 x H 7 cm / dimensions L 97 x P 41,5 x H 7 cm

Per basi portalavabo L 95 x P 37 cm / for washbasin units W 95 x D 37 cm / base lavabo L 95 x P 37 cm

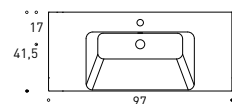

Art. **A444** - P. 358



Bart 107

Consolle H 7 cm (con foro troppo pieno)
 H 7 cm console (with overflow)
 Consolle H 7 cm (avec trop-plein)

Ceramica / ceramic / céramique

Dimensioni L 107 x P 41,5 x H 7 cm / full sizes W 107 x D 41,5 x H 7 cm / dimensions L 107 x P 41,5 x H 7 cm

Per basi portalavabo L 107 x P 37 cm / for washbasin units W 107 x D 37 cm / base lavabo L 107 x P 37 cm

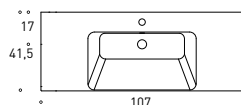

Art. **A445** - P. 358

Today

mineralguss/mineralguss/mineralguss



reddot award 2017
best of the best



MENEGHELLO PAOLELLI
ASSOCIATI



Today 61

Consolle H 8 cm (senza foro troppo pieno)
H 8 cm console (without overflow)
Consolle H 8 cm (sans trop-plein)

Mineralguss / mineralguss / mineralguss

Dimensioni L 61 x P 43 x H 8 cm / full sizes W 61 x D 43 x H 8 cm / dimensions L 61 x P 43 x H 8 cm
Per basi portlavabo L 60 x P 37 cm / for washbasin units W 60 x D 37 cm / base lavabo L 60 x P 37 cm

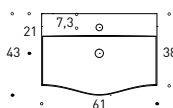

Art. **A366** - P. 359



Today 71

Consolle H 8 cm (senza foro troppo pieno)
 H 8 cm console (without overflow)
 Consolle H 8 cm (sans trop-plein)

[Mineralguss](#) / [mineralguss](#) / [mineralguss](#)

Dimensioni L 71 x P 43 x H 8 cm / full sizes W 71 x D 43 x H 8 cm / dimensions L 71 x P 43 x H 8 cm

Per basi portalavabo L 70 x P 37 cm / for washbasin units W 70 x D 37 cm / base lavabo L 70 x P 37 cm

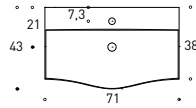

Art. **A367** - P. 359



Today 86

Consolle H 8 cm (senza foro troppo pieno)
 H 8 cm console (without overflow)
 Consolle H 8 cm (sans trop-plein)

[Mineralguss](#) / [mineralguss](#) / [mineralguss](#)

Dimensioni L 86 x P 43 x H 8 cm / full sizes W 86 x D 43 x H 8 cm / dimensions L 86 x P 43 x H 8 cm

Per basi portalavabo L 85 x P 37 cm / for washbasin units W 85 x D 37 cm / base lavabo L 85 x P 37 cm

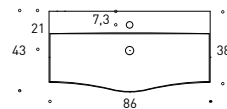

Art. **A368** - P. 359



Today 96

Consolle H 8 cm (senza foro troppo pieno)
 H 8 cm console (without overflow)
 Consolle H 8 cm (sans trop-plein)

[Mineralguss](#) / [mineralguss](#) / [mineralguss](#)

Dimensioni L 96 x P 43 x H 8 cm / full sizes W 96 x D 43 x H 8 cm / dimensions L 96 x P 43 x H 8 cm

Per basi portalavabo L 95 x P 37 cm / for washbasin units W 95 x D 37 cm / base lavabo L 95 x P 37 cm

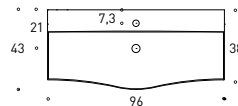

Art. **A369** - P. 359



Today 106

Consolle H 8 cm (senza foro troppo pieno)
 H 8 cm console (without overflow)
 Consolle H 8 cm (sans trop-plein)

[Mineralguss](#) / [mineralguss](#) / [mineralguss](#)

Dimensioni L 106 x P 43 x H 8 cm / full sizes W 106 x D 43 x H 8 cm / dimensions L 106 x P 43 x H 8 cm

Per basi portalavabo L 105 x P 37 cm / for washbasin units W 105 x D 37 cm / base lavabo L 105 x P 37 cm

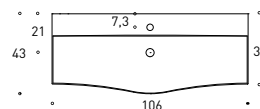

Art. **A370** - P. 359

Worktek

ceramica/ceramic/c eramique



Worktek 71

Consolle H 2,5 + 14 cm (senza foro troppo pieno)
H 2,5 + 14 cm console (without overflow)
Consolle H 2,5 + 14 cm (sans trop-plein)

Ceramica / ceramic / c eramique

Dimensioni L 71 x P 51,5 x H 2,5+14 cm / full sizes W 71 x D 51,5 x H 2,5+14 cm / dimensions L 71 x P 51,5 x H 2,5+14 cm

Per basi portalavabo L 70 x P 50 cm / for washbasin units W 70 x D 50 cm / base lavabo L 70 x P 50 cm

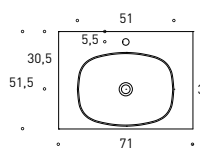

Art. **A465** - P. 360



Worktek 86

Consolle H 2,5 + 14 cm (senza foro troppo pieno)
H 2,5 + 14 cm console (without overflow)
Consolle H 2,5 + 14 cm (sans trop-plein)

Ceramica / ceramic / c eramique

Dimensioni L 86 x P 51,5 x H 2,5+14 cm / full sizes W 86 x D 51,5 x H 2,5+14 cm / dimensions L 86 x P 51,5 x H 2,5+14 cm

Per basi portalavabo L 85 x P 50 cm / for washbasin units W 85 x D 50 cm / base lavabo L 85 x P 50 cm

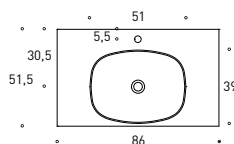

Art. **A466** - P. 360



Worktek 96

Consolle H 2,5 + 14 cm (senza foro troppo pieno)
 H 2,5 + 14 cm console (without overflow)
 Consolle H 2,5 + 14 cm (sans trop-plein)

Ceramica / ceramic / céramique

Dimensioni L 96 x P 51,5 x H 2,5+14 cm / full sizes W 96 x D 51,5 x H 2,5+14 cm / dimensions L 96 x P 51,5 x H 2,5+14 cm

Per basi portalavabo L 95 x P 50 cm / for washbasin units W 95 x D 50 cm / base lavabo L 95 x P 50 cm

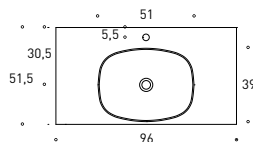

Art. **A467** - P. 360



Worktek 106

Consolle H 2,5 + 14 cm (senza foro troppo pieno)
 H 2,5 + 14 cm console (without overflow)
 Consolle H 2,5 + 14 cm (sans trop-plein)

Ceramica / ceramic / céramique

Dimensioni L 106 x P 51,5 x H 2,5+14 cm / full sizes W 106 x D 51,5 x H 2,5+14 cm / dimensions L 106 x P 51,5 x H 2,5+14 cm

Per basi portalavabo L 105 x P 50 cm / for washbasin units W 105 x D 50 cm / base lavabo L 105 x P 50 cm

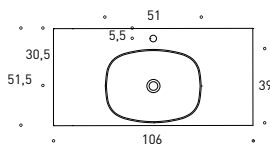

Art. **A468** - P. 360



Worktek 106 dx-sx / rh-lh / dr-ga

Consolle H 2,5 + 14 cm (senza foro troppo pieno)
 H 2,5 + 14 cm console (without overflow)
 Consolle H 2,5 + 14 cm (sans trop-plein)

Ceramica / ceramic / céramique

Dimensioni L 106 x P 51,5 x H 2,5+14 cm / full sizes W 106 x D 51,5 x H 2,5+14 cm / dimensions L 106 x P 51,5 x H 2,5+14 cm

Per basi portalavabo L 105 x P 50 cm / for washbasin units W 105 x D 50 cm / base lavabo L 105 x P 50 cm

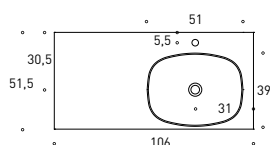

Art. **A469** (dx / rh / dr) - P. 360 - Art. **A470** (sx / lh / ga) - P. 360



Worktek 121

Consolle H 2,5 + 14 cm (senza foro troppo pieno)
 H 2,5 + 14 cm console (without overflow)
 Consolle H 2,5 + 14 cm (sans trop-plein)

Ceramica / ceramic / céramique

Dimensioni L 121 x P 51,5 x H 2,5+14 cm / full sizes W 121 x D 51,5 x H 2,5+14 cm / dimensions L 121 x P 51,5 x H 2,5+14 cm

Per basi portalavabo L 120 x P 50 cm / for washbasin units W 120 x D 50 cm / base lavabo L 120 x P 50 cm

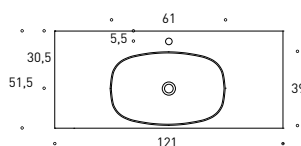

Art. **A471** - P. 360

Movado

ceramica/ceramic/c eramique



Movado 71

Consolle H 2,5 + 3 cm (con foro troppo pieno)
H 2,5 + 3 cm console (with overflow)
Consolle H 2,5 + 3 cm (avec trop-plein)

Ceramica / ceramic / c eramique

Dimensioni L 71 x P 51,5 x H 2,5 + 3 cm / full sizes W 71 x D 51,5 x H 2,5 + 3 cm / dimensions L 71 x P 51,5 x H 2,5 + 3 cm

Per basi portalavabo L 70 x P 50 cm / for washbasin units W 70 x D 50 cm / base lavabo L 70 x P 50 cm

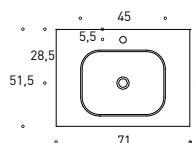

Art. **A472** - P. 361



Movado 86

Consolle H 2,5 + 3 cm (con foro troppo pieno)
H 2,5 + 3 cm console (with overflow)
Consolle H 2,5 + 3 cm (avec trop-plein)

Ceramica / ceramic / c eramique

Dimensioni L 86 x P 51,5 x H 2,5 + 3 cm / full sizes W 86 x D 51,5 x H 2,5 + 3 cm / dimensions L 86 x P 51,5 x H 2,5 + 3 cm

Per basi portalavabo L 85 x P 50 cm / for washbasin units W 85 x D 50 cm / base lavabo L 85 x P 50 cm

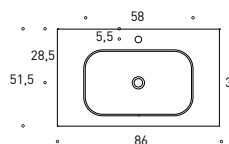

Art. **A473** - P. 361



Movado 96

Consolle H 2,5 + 3 cm (con foro troppo pieno)
 H 2,5 + 3 cm console (with overflow)
 Consolle H 2,5 + 3 cm (avec trop-plein)

Ceramica / ceramic / céramique

Dimensioni L 96 x P 51,5 x H 2,5 + 3 cm / full sizes W 96 x D 51,5 x H 2,5 + 3 cm / dimensions
 L 96 x P 51,5 x H 2,5 + 3 cm

Per basi portalavabo L 95 x P 50 cm / for washbasin units W 95 x D 50 cm / base lavabo L 95 x
 P 50 cm

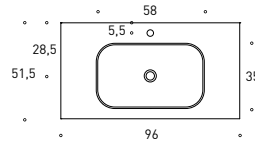

Art. **A474** - P. 361



Movado 106

Consolle H 2,5 + 3 cm (con foro troppo pieno)
 H 2,5 + 3 cm console (with overflow)
 Consolle H 2,5 + 3 cm (avec trop-plein)

Ceramica / ceramic / céramique

Dimensioni L 106 x P 51,5 x H 2,5 + 3 cm / full sizes W 106 x D 51,5 x H 2,5 + 3 cm / dimensions
 L 106 x P 51,5 x H 2,5 + 3 cm

Per basi portalavabo L 105 x P 50 cm / for washbasin units W 105 x D 50 cm / base lavabo L 105
 x P 50 cm

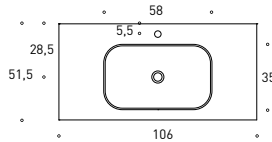

Art. **A475** - P. 361



Movado 106 dx-sx / rh-lh / dr-ga

Consolle H 2,5 + 3 cm (con foro troppo pieno)
 H 2,5 + 3 cm console (with overflow)
 Consolle H 2,5 + 3 cm (avec trop-plein)

Ceramica / ceramic / céramique

Dimensioni L 106 x P 51,5 x H 2,5 + 3 cm / full sizes W 106 x D 51,5 x H 2,5 + 3 cm / dimensions
 L 106 x P 51,5 x H 2,5 + 3 cm

Per basi portalavabo L 105 x P 50 cm / for washbasin units W 105 x D 50 cm / base lavabo L 105
 x P 50 cm

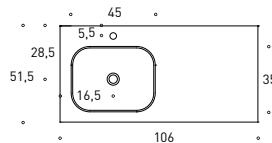

Art. **A476** (dx / rh / dr) - P. 361 - Art. **A477** (sx / lh / ga) - P. 361



Movado 121

Consolle H 2,5 + 3 cm (con foro troppo pieno)
 H 2,5 + 3 cm console (with overflow)
 Consolle H 2,5 + 3 cm (avec trop-plein)

Ceramica / ceramic / céramique

Dimensioni L 121 x P 51,5 x H 2,5 + 3 cm / full sizes W 121 x D 51,5 x H 2,5 + 3 cm / dimensions
 L 121 x P 51,5 x H 2,5 + 3 cm

Per basi portalavabo L 120 x P 50 cm / for washbasin units W 120 x D 50 cm / base lavabo L 120
 x P 50 cm

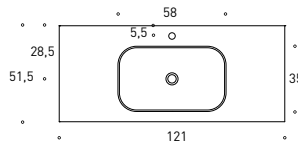

Art. **A478** - P. 361

Qubo

ceramica/ceramic/c eramique



Qubo 71

Consolle H 1,5 cm (con foro troppo pieno)
H 1,5 cm console (with overflow)
Consolle H 1,5 cm (avec trop-plein)

Ceramica / ceramic / c eramique

Dimensioni L 71 x P 51,5 x H 1,5 cm / full sizes W 71 x D 51,5 x H 1,5 cm / dimensions L 71 x P 51,5 x H 1,5 cm

Per monoblocco L 70 x P 50 cm / for washbasin units W 70 x D 50 cm / base lavabo L 70 x P 50 cm

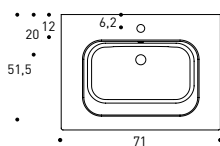

Art. **A736** - P. 362



Qubo 86

Consolle H 1,5 cm (con foro troppo pieno)
H 1,5 cm console (with overflow)
Consolle H 1,5 cm (avec trop-plein)

Ceramica / ceramic / c eramique

Dimensioni L 86 x P 51,5 x H 1,5 cm / full sizes W 86 x D 51,5 x H 1,5 cm / dimensions L 86 x P 51,5 x H 1,5 cm

Per monoblocco L 85 x P 50 cm / for washbasin units W 85 x D 50 cm / base lavabo L 85 x P 50 cm

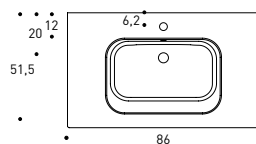

Art. **A737** - P. 362



Qubo 96

Consolle H 1,5 cm (con foro troppo pieno)
 H 1,5 cm console (with overflow)
 Consolle H 1,5 cm (avec trop-plein)

Ceramica / ceramic / céramique

Dimensioni L 96 x P 51,5 x H 1,5 cm / full sizes W 96 x D 51,5 x H 1,5 cm / dimensions L 96 x P 51,5 x H 1,5 cm

Per monoblocco L 95 x P 50 cm / for washbasin units W 95 x D 50 cm / base lavabo L 95 x P 50 cm

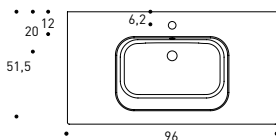

Art. **A738** - P. 362



Qubo 106

Consolle H 1,5 cm (con foro troppo pieno)
 H 1,5 cm console (with overflow)
 Consolle H 1,5 cm (avec trop-plein)

Ceramica / ceramic / céramique

Dimensioni L 106 x P 51,5 x H 1,5 cm / full sizes W 106 x D 51,5 x H 1,5 cm / dimensions L 106 x P 51,5 x H 1,5 cm

Per monoblocco L 105 x P 50 cm / for washbasin units W 105 x D 50 cm / base lavabo L 105 x P 50 cm

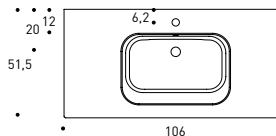

Art. **A739** - P. 362



Qubo 106 dx-sx / rh-lh / dr-ga

Consolle H 1,5 cm (con foro troppo pieno)
 H 1,5 cm console (with overflow)
 Consolle H 1,5 cm (avec trop-plein)

Ceramica / ceramic / céramique

Dimensioni L 106 x P 51,5 x H 1,5 cm / full sizes W 106 x D 51,5 x H 1,5 cm / dimensions L 106 x P 51,5 x H 1,5 cm

Per monoblocco L 105 x P 50 cm / for washbasin units W 105 x D 50 cm / base lavabo L 105 x P 50 cm

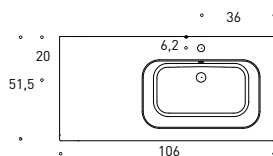

Art. **A371** (dx / rh / dr) - P. 362 - Art. **A372** (sx / lh / ga) - P. 362



Qubo 121

Consolle H 1,5 cm (con foro troppo pieno)
 H 1,5 cm console (with overflow)
 Consolle H 1,5 cm (avec trop-plein)

Ceramica / ceramic / céramique

Dimensioni L 121 x P 51,5 x H 1,5 cm / full sizes W 121 x D 51,5 x H 1,5 cm / dimensions L 121 x P 51,5 x H 1,5 cm

Per monoblocco L 120 x P 50 cm / for washbasin units W 120 x D 50 cm / base lavabo L 120 x P 50 cm

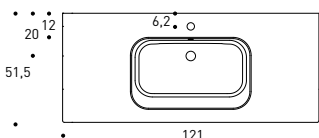

Art. **A036** - P. 362



Qubo 121 dx-sx / rh-lh / dr-ga

Consolle H 1,5 cm (con foro troppo pieno)
 H 1,5 cm console (with overflow)
 Consolle H 1,5 cm (avec trop-plein)

Ceramica / ceramic / céramique

Dimensioni L 121 x P 51,5 x H 1,5 cm / full sizes W 121 x D 51,5 x H 1,5 cm / dimensions L 121 x P 51,5 x H 1,5 cm

Per monoblocco L 120 x P 50 cm / for washbasin units W 120 x D 50 cm / base lavabo L 120 x P 50 cm

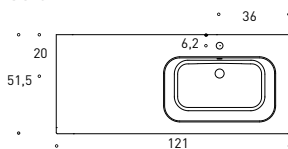

Art. **A373** (dx / rh / dr) - P. 362 - Art. **A374** (sx / lh / ga) - P. 362



Qubo 121 doppia vasca / twin sink / double vasque

Ceramica / ceramic / céramique

Dimensioni L 121 x P 51,5 x H 1,5 cm / full sizes W 121 x D 51,5 x H 1,5 cm / dimensions L 121 x P 51,5 x H 1,5 cm

Per monoblocco L 120 x P 50 cm / for washbasin units W 120 x D 50 cm / base lavabo L 120 x P 50 cm

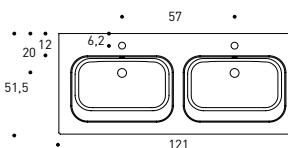

Art. **A735** - P. 362



Spa

ceramica/ceramic/c eramique



Spa 71

Consolle H 1,5 cm (con foro troppo pieno)
H 1,5 cm console (with overflow)
Consolle H 1,5 cm (avec trop-plein)

Ceramica / ceramic / c eramique

Dimensioni L 71 x P 51,5 x H 1,5 cm / full sizes W 71 x D 51,5 x H 1,5 cm / dimensions L 71 x P 51,5 x H 1,5 cm

Per basi portalavabo L 70 x P 50 cm / for washbasin units W 70 x D 50 cm / base lavabo L 70 x P 50 cm

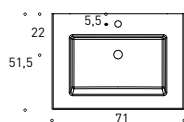

Art. **A126** - P. 363



Spa 86

Consolle H 1,5 cm (con foro troppo pieno)
 H 1,5 cm console (with overflow)
 Consolle H 1,5 cm (avec trop-plein)

Ceramica / ceramic / céramique

Dimensioni L 86 x P 51,5 x H 1,5 cm / full sizes W 86 x D 51,5 x H 1,5 cm / dimensions L 86 x P 51,5 x H 1,5 cm

Per basi portalavabo L 85 x P 50 cm / for washbasin units W 85 x D 50 cm / base lavabo L 85 x P 50 cm

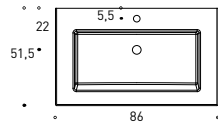

Art. **A127** - P. 363



Spa 96

Consolle H 1,5 cm (con foro troppo pieno)
 H 1,5 cm console (with overflow)
 Consolle H 1,5 cm (avec trop-plein)

Ceramica / ceramic / céramique

Dimensioni L 96 x P 51,5 x H 1,5 cm / full sizes W 96 x D 51,5 x H 1,5 cm / dimensions L 96 x P 51,5 x H 1,5 cm

Per basi portalavabo L 95 x P 50 cm / for washbasin units W 95 x D 50 cm / base lavabo L 95 x P 50 cm

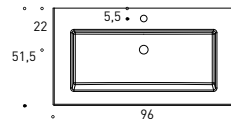

Art. **A128** - P. 363



Spa 106

Consolle H 1,5 cm (con foro troppo pieno)
 H 1,5 cm console (with overflow)
 Consolle H 1,5 cm (avec trop-plein)

Ceramica / ceramic / céramique

Dimensioni L 106 x P 51,5 x H 1,5 cm / full sizes W 106 x D 51,5 x H 1,5 cm / dimensions L 106 x P 51,5 x H 1,5 cm

Per basi portalavabo L 105 x P 50 cm / for washbasin units W 105 x D 50 cm / base lavabo L 105 x P 50 cm

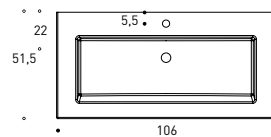

Art. **A129** - P. 363



Spa 121

Consolle H 1,5 cm (con foro troppo pieno)
 H 1,5 cm console (with overflow)
 Consolle H 1,5 cm (avec trop-plein)

Ceramica / ceramic / céramique

Dimensioni L 121 x P 51,5 x H 1,5 cm / full sizes W 121 x D 51,5 x H 1,5 cm / dimensions L 121 x P 51,5 x H 1,5 cm

Per basi portalavabo L 120 x P 50 cm / for washbasin units W 120 x D 50 cm / base lavabo L 120 x P 50 cm

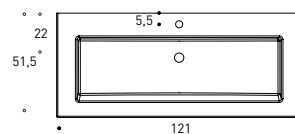

Art. **A130** - P. 363



Melody

ceramica/ceramic/c ramique



Melody 72

Consolle H 1,5 cm (con foro troppo pieno)
H 1,5 cm console (with overflow)
Consolle H 1,5 cm (avec trop-plein)

Ceramica / ceramic / c ramique

Dimensioni L 72 x P 51,5 x H 1,5 cm / full sizes W 72 x D 51,5 x H 1,5 cm / dimensions L 72 x P 51,5 x H 1,5 cm

Per basi portalavabo L 70 x P 50 cm / for washbasin units W 70 x D 50 cm / base lavabo L 70 x P 50 cm

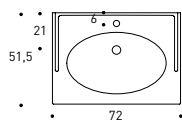

Art. **A217** - P. 363



Melody 107

Consolle H 1,5 cm (con foro troppo pieno)
H 1,5 cm console (with overflow)
Consolle H 1,5 cm (avec trop-plein)

Ceramica / ceramic / c ramique

Dimensioni L 107 x P 51,5 x H 1,5 cm / full sizes W 107 x D 51,5 x H 1,5 cm / dimensions L 107 x P 51,5 x H 1,5 cm

Per basi portalavabo L 105 x P 50 cm / for washbasin units W 105 x D 50 cm / base lavabo L 105 x P 50 cm

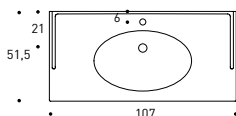

Art. **A218** - P. 363



Melody 122

Consolle H 1,5 cm (con foro troppo pieno)
H 1,5 cm console (with overflow)
Consolle H 1,5 cm (avec trop-plein)

Ceramica / ceramic / c ramique

Dimensioni L 122 x P 51,5 x H 1,5 cm / full sizes W 122 x D 51,5 x H 1,5 cm / dimensions L 122 x P 51,5 x H 1,5 cm

Per basi portalavabo L 120 x P 50 cm / for washbasin units W 120 x D 50 cm / base lavabo L 120 x P 50 cm

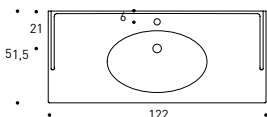

Art. **A219** - P. 363

Curvy

mineralguss/mineralguss/mineralguss



Curvy 71

Consolle H 1,2 cm (con foro troppo pieno)

H 1,2 cm console (with overflow)

Consolle H 1,2 cm (avec trop-plein)

Mineralguss / mineralguss / mineralguss

Dimensioni L 71 x P 51,5 x H 1,2 cm / full sizes W 71 x D 51,5 x H 1,2 cm / dimensions L 71 x P 51,5 x H 1,2 cm

Per basi portalavabo L 70 x P 50 cm / for washbasin units W 70 x D 50 cm / base lavabo L 70 x P 50 cm

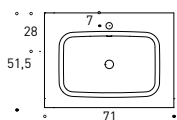

Art. **A381** - P. 365



Curvy 86

Consolle H 1,2 cm (con foro troppo pieno)
 H 1,2 cm console (with overflow)
 Consolle H 1,2 cm (avec trop-plein)

[Mineralguss](#) / [mineralguss](#) / [mineralguss](#)

Dimensioni L 86 x P 51,5 x H 1,2 cm / full sizes W 86 x D 51,5 x H 1,2 cm / dimensions L 86 x P 51,5 x H 1,2 cm

Per basi portalavabo L 85 x P 50 cm / for washbasin units W 85 x D 50 cm / base lavabo L 85 x P 50 cm

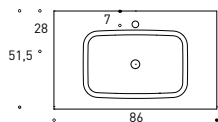

Art. **A382** - P. 365



Curvy 96

Consolle H 1,2 cm (con foro troppo pieno)
 H 1,2 cm console (with overflow)
 Consolle H 1,2 cm (avec trop-plein)

[Mineralguss](#) / [mineralguss](#) / [mineralguss](#)

Dimensioni L 96 x P 51,5 x H 1,2 cm / full sizes W 96 x D 51,5 x H 1,2 cm / dimensions L 96 x P 51,5 x H 1,2 cm

Per basi portalavabo L 95 x P 50 cm / for washbasin units W 95 x D 50 cm / base lavabo L 95 x P 50 cm

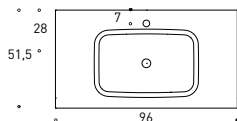

Art. **A383** - P. 365



Curvy 106

Consolle H 1,2 cm (con foro troppo pieno)
 H 1,2 cm console (with overflow)
 Consolle H 1,2 cm (avec trop-plein)

[Mineralguss](#) / [mineralguss](#) / [mineralguss](#)

Dimensioni L 106 x P 51,5 x H 1,2 cm / full sizes W 106 x D 51,5 x H 1,2 cm / dimensions L 106 x P 51,5 x H 1,2 cm

Per basi portalavabo L 105 x P 50 cm / for washbasin units W 105 x D 50 cm / base lavabo L 105 x P 50 cm

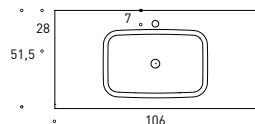

Art. **A384** - P. 365



Curvy 121

Consolle H 1,2 cm (con foro troppo pieno)
 H 1,2 cm console (with overflow)
 Consolle H 1,2 cm (avec trop-plein)

[Mineralguss](#) / [mineralguss](#) / [mineralguss](#)

Dimensioni L 121 x P 51,5 x H 1,2 cm / full sizes W 121 x D 51,5 x H 1,2 cm / dimensions L 121 x P 51,5 x H 1,2 cm

Per basi portalavabo L 120 x P 50 cm / for washbasin units W 120 x D 50 cm / base lavabo L 120 x P 50 cm

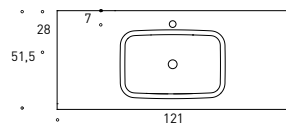

Art. **A385** - P. 365

Letter

mineralguss/mineralguss/mineralguss



MENEGHELLO PAOLELLI
ASSOCIATI

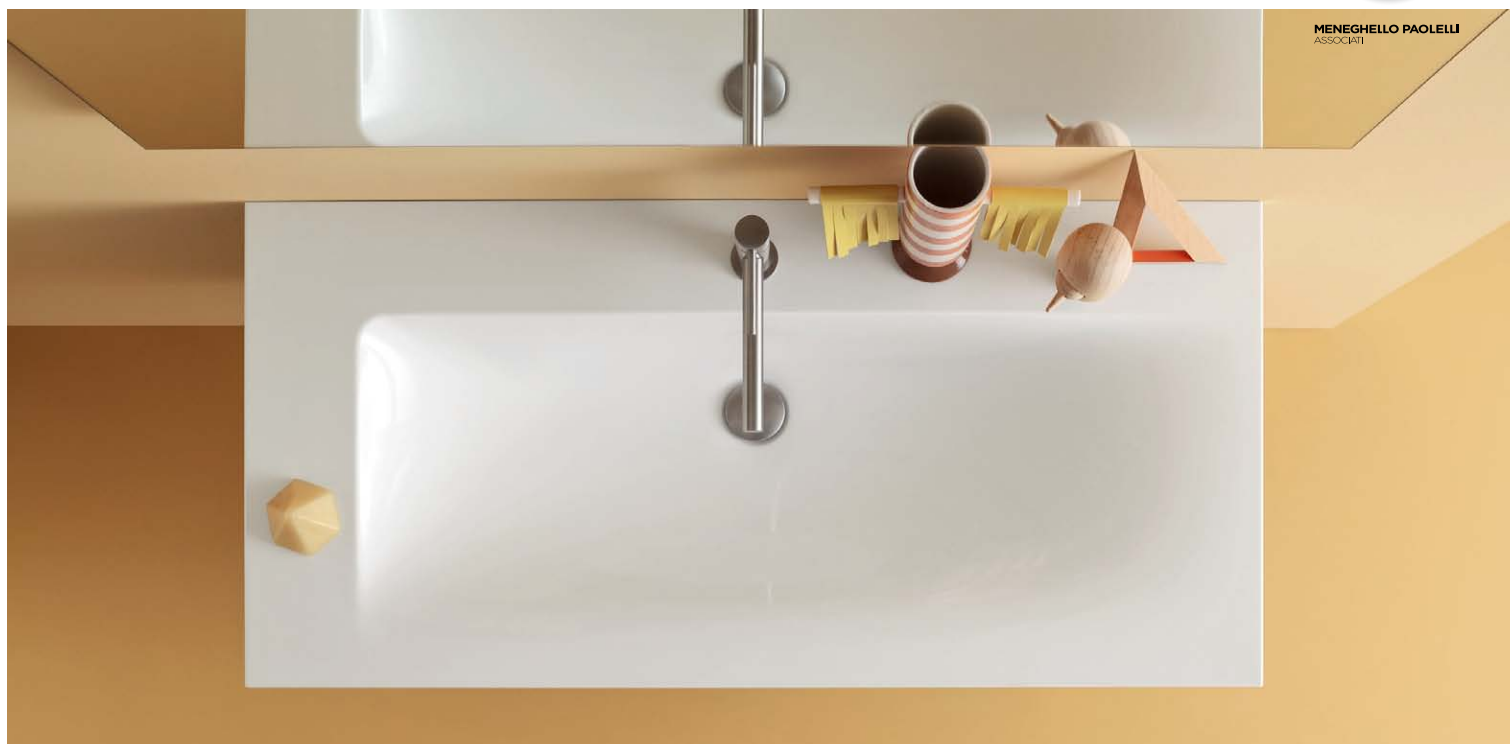

Letter 61

Consolle H 1,5 cm (senza foro troppo pieno)

Th. 1,5 cm consolle (without overflow)

Consolle H 1,5 cm (sans trop-plein)

Mineralguss / mineralguss / mineralguss

Dimensioni L 61 x P 50,8 x H 1,5 cm / full sizes W 61 x D 50,8 x H 1,5 cm / dimensions L 61 x P 50,8 x H 1,5 cm

Per basi port lavabo L 60 x P 50 cm / for washbasin units W 60 x D 50 cm / base lavabo L 60 x P 50 cm

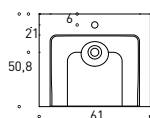

Art. **A278** - P. 364



Letter 71

Consolle H 1,5 cm (senza foro troppo pieno)

Th. 1,5 cm consolle (without overflow)

Consolle H 1,5 cm (sans trop-plein)

Mineralguss / mineralguss / mineralguss

Dimensioni L 71 x P 50,8 x H 1,5 cm / full sizes W 71 x D 50,8 x H 1,5 cm / dimensions L 71 x P 50,8 x H 1,5 cm

Per basi port lavabo L 70 x P 50 cm / for washbasin units W 70 x D 50 cm / base lavabo L 70 x P 50 cm

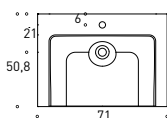

Art. **A279** - P. 364



Letter 86 dx-sx / rh-lh / dr-ga

Consolle H 1,5 cm (senza foro troppo pieno)
Th. 1,5 cm console (without overflow)
Consolle H 1,5 cm (sans trop-plein)

Ceramica / ceramic / céramique

Dimensioni L 86 x P 50,8 x H 1,5 cm / full sizes W 86 x D 50,8 x H 1,5 cm / dimensions L 86 x P 50,8 x H 1,5 cm

Per basi portalavabo L 85 x P 50 cm / for washbasin units W 85 x D 50 cm / base lavabo L 85 x P 50 cm

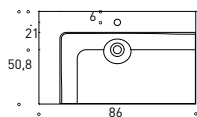

DX

Art. **A280** (dx / rh / dr) - P. 364 - Art. **A281** (sx / lh / ga) - P. 364



Letter 96 dx-sx / rh-lh / dr-ga

Consolle H 1,5 cm (senza foro troppo pieno)
Th. 1,5 cm console (without overflow)
Consolle H 1,5 cm (sans trop-plein)

Ceramica / ceramic / céramique

Dimensioni L 96 x P 50,8 x H 1,5 cm / full sizes W 96 x D 50,8 x H 1,5 cm / dimensions L 96 x P 50,8 x H 1,5 cm

Per basi portalavabo L 95 x P 50 cm / for washbasin units W 95 x D 50 cm / base lavabo L 95 x P 50 cm

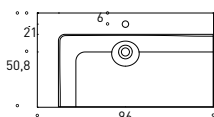

DX

Art. **A282** (dx / rh / dr) - P. 364 - Art. **A283** (sx / lh / ga) - P. 364



Letter 106 dx-sx / rh-lh / dr-ga

Consolle H 1,5 cm (senza foro troppo pieno)
Th. 1,5 cm console (without overflow)
Consolle H 1,5 cm (sans trop-plein)

Ceramica / ceramic / céramique

Dimensioni L 106 x P 50,8 x H 1,5 cm / full sizes W 106 x D 50,8 x H 1,5 cm / dimensions L 106 x P 50,8 x H 1,5 cm

Per basi portalavabo L 105 x P 50 cm / for washbasin units W 105 x D 50 cm / base lavabo L 105 x P 50 cm

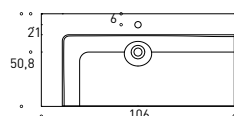

DX

Art. **A284** (dx / rh / dr) - P. 364 - Art. **A285** (sx / lh / ga) - P. 364



Letter 121

Consolle H 1,5 cm (senza foro troppo pieno)
Th. 1,5 cm console (without overflow)
Consolle H 1,5 cm (sans trop-plein)

Ceramica / ceramic / céramique

Dimensioni L 121 x P 50,8 x H 1,5 cm / full sizes W 121 x D 50,8 x H 1,5 cm / dimensions L 121 x P 50,8 x H 1,5 cm

Per basi portalavabo L 120 x P 50 cm / for washbasin units W 120 x D 50 cm / base lavabo L 120 x P 50 cm

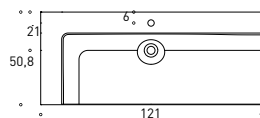

DX

Art. **A293** (dx / rh / dr) - P. 364 - Art. **A294** (sx / lh / ga) - P. 364



Letter 121 doppia vasca / twin sink / double vasque

Consolle H 1,5 cm (senza foro troppo pieno)

Th. 1,5 cm console (without overflow)

Consolle H 1,5 cm (sans trop-plein)

Mineralguss / mineralguss / mineralguss

Dimensioni L 121 x P 50,8 x H 1,5 cm / full sizes W 121 x D 50,8 x H 1,5 cm / dimensions L 121 x P 50,8 x H 1,5 cm

Per basi portlavabo L 120 x P 50 cm / for washbasin units W 120 x D 50 cm / base lavabo L 120 x P 50 cm

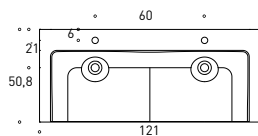

Art. **A295** - P. 364



Letter 141 doppia vasca / twin sink / double vasque

Consolle H 1,5 cm (senza foro troppo pieno)

Th. 1,5 cm console (without overflow)

Consolle H 1,5 cm (sans trop-plein)

Mineralguss / mineralguss / mineralguss

Dimensioni L 141 x P 50,8 x H 1,5 cm / full sizes W 141 x D 50,8 x H 1,5 cm / dimensions L 141 x P 50,8 x H 1,5 cm

Per basi portlavabo L 140 x P 50 cm / for washbasin units W 140 x D 50 cm / base lavabo L 140 x P 50 cm

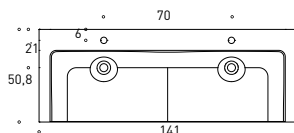

Art. **A296** - P. 364





Rodi

mineralguss/mineralguss/mineralguss



Rodi 71

Consolle H 1,2 cm (senza foro troppo pieno)
Th. 1,2 cm console (without overflow)
Consolle H 1,2 cm (sans trop-plein)

Mineralguss / mineralguss / mineralguss

Dimensioni L 71 x P 51 x H 1,2 cm / full sizes W 71 x D 51 x H 1,2 cm / dimensions L 71 x P 51 x H 1,2 cm

Per basi portalavabo L 70 x P 50 cm / for washbasin units W 70 x D 50 cm / base lavabo L 70 x P 50 cm

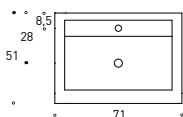

Art. **A438** - P. 365



Rodi 86

Consolle H 1,2 cm (senza foro troppo pieno)
Th. 1,2 cm console (without overflow)
Consolle H 1,2 cm (sans trop-plein)

Mineralguss / mineralguss / mineralguss

Dimensioni L 86 x P 51 x H 1,2 cm / full sizes W 86 x D 51 x H 1,2 cm / dimensions L 86 x P 51 x H 1,2 cm

Per basi portalavabo L 85 x P 50 cm / for washbasin units W 85 x D 50 cm / base lavabo L 85 x P 50 cm

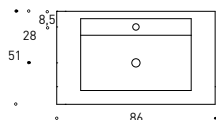

Art. **A439** - P. 365



Rodi 96

Consolle H 1,2 cm (senza foro troppo pieno)
Th. 1,2 cm console (without overflow)
Consolle H 1,2 cm (sans trop-plein)

Mineralguss / mineralguss / mineralguss

Dimensioni L 96 x P 51 x H 1,2 cm / full sizes W 96 x D 51 x H 1,2 cm / dimensions L 96 x P 51 x H 1,2 cm

Per basi portalavabo L 95 x P 50 cm / for washbasin units W 95 x D 50 cm / base lavabo L 95 x P 50 cm

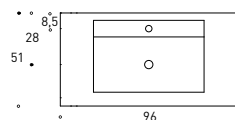

Art. **A450** - P. 365



Kreo

Piano top sp. 1,2 cm (senza foro troppo pieno)
Th. 1,2 cm top (without overflow)
Plan de toilette H 1,2 cm (sans trop-plein)

Vasca L 59,6 x P 35 x H 13 cm / interior W 59,6 x D 35 x H 13 cm
cm / vasque int. L 59,6 x P 35 x H 13 cm

Per basi portalavabo min. L 70 x P 37 cm / for washbasin units min. W 70 x D 37 cm / base lavabo L 70 x P 37 cm

Finiture / finishes / finitions:

mineralguss:

tekno:



bianco



bianco

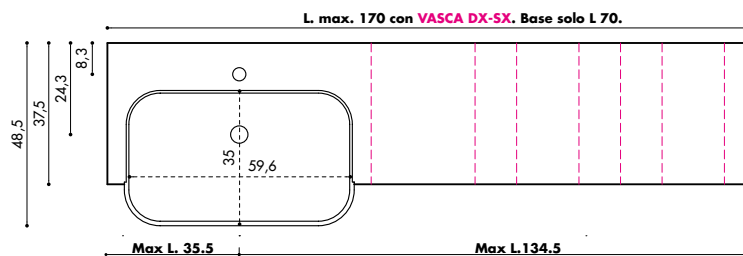

Art. F007

Per mobile da L 70 a 110 cm
con vasca dx-sx

P. 366

Art. F008

Per mobile da L 111 a 140 cm
con vasca dx-sx

P. 366

Art. F009

Per mobile da L 141 a 170 cm
con vasca dx-sx

P. 366

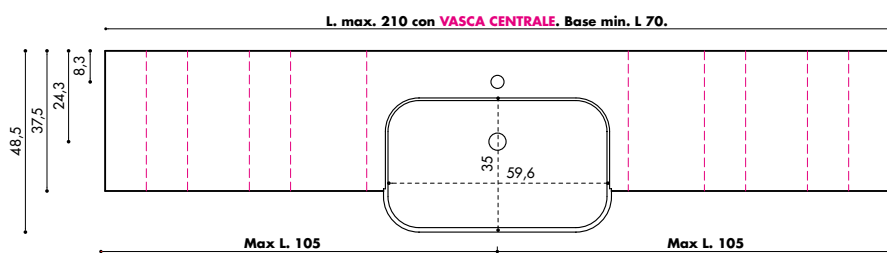

Art. F010

Per mobile da L 70 a 170 cm
solo vasca centrale

P. 366

Art. F011

Per mobile da L 171 a 210 cm
solo vasca centrale

P. 366



Loft

Piani top sp. 1,5 cm (senza foro troppo pieno)
Th. 1,5 cm top (without overflow)
Plan de toilette H 1,5 cm (sans trop-plein)

Vasca L 60 x P 32 x H 14 cm / interior W 60 x D 32 x H 14 cm
/ vasque int. L 60 x P 32 x H 14 cm

Per basi portalavabo min. L 70 x P 37 cm / for washbasin units min.
W 70 x D 37 cm / base lavabo L 70 x P 37 cm

Finiture / finishes / finitions:

mineralguss:



bianco

L. max. 141 con **VASCA DX-SX**. Base solo L 70.

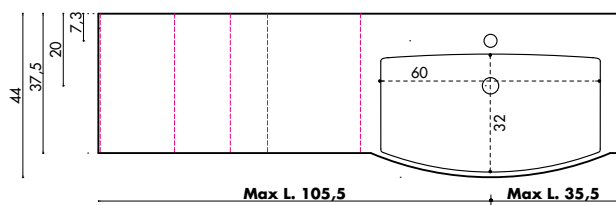

L. max. 141 con **VASCA CENTRALE**. Base min. L 70.

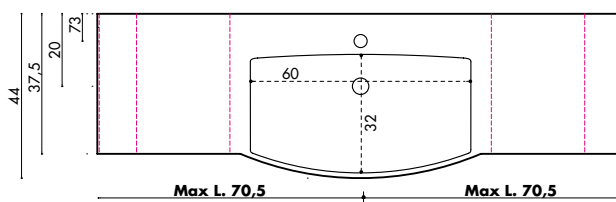

L. max. 171 con **VASCA CENTRALE**. Base min L 70.

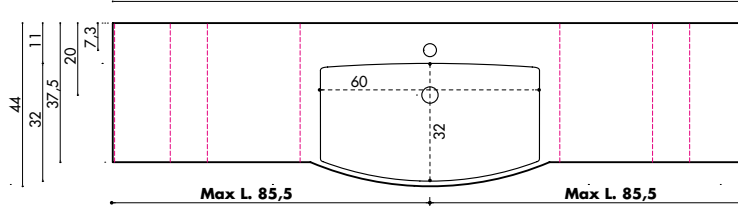

Art. A197

Per mobile da L 70 a 140 cm
con vasca dx-sx

P. 367

Art. A198

Per mobile da L 70 a 140 cm
con vasca centrale

P. 367

Art. A199

Per mobile da L 70 a 170 cm
solo vasca centrale

P. 367





Joy

Piani top sp. 1,4 cm (con foro troppo pieno)
 Th. 1,4 cm tops (with overflow)
 Plan de toilette top H 1,4 cm (avec trop-plein)

Mineralguss / mineralguss / mineralguss

Vasca L 60 x P 33 x H 14 cm / interior W 60 x D 33 x H 14 cm / vasque int. L 60 x P 33 x H 14 cm

L. max. 175 con **VASCA CENTRALE**. Base min. L 70.

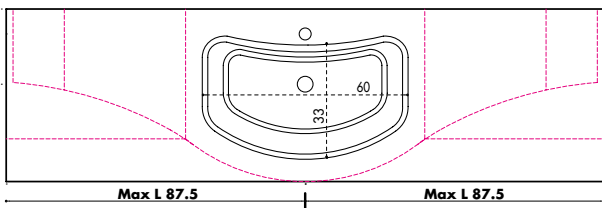

Art. F701

Per basi portalavabo
 min. L 70 x P 50 cm

P. 369

L. max. 211 con **VASCA CENTRALE**. Base min. L 70.

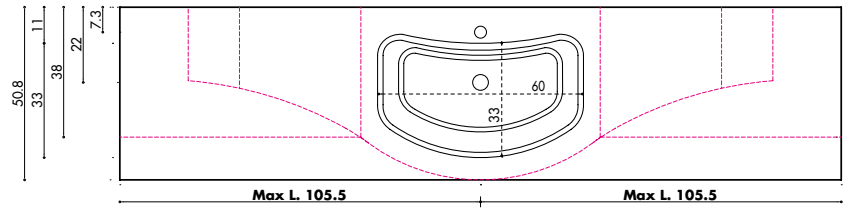

Art. F801

Per basi portalavabo
 min. L 70 x P 50 cm

P. 369



Joker

Piano top sp. 1,4 cm (con foro troppo pieno)
 Th. 1,4 cm tops (with overflow)
 Plan de toilette H 1,4 cm (avec trop-plein)

Mineralguss / mineralguss / mineralguss

Vasca L 77 x P 33 x H 14 cm / interior W 77 x D 33 x H 14 cm / vasque int. L 77 x P 33 x H 14 cm

L. max. 186 con **VASCA CENTRALE**. Base min. L 85.

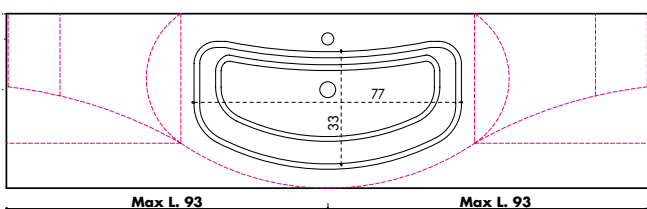

Art. F702

Per basi portalavabo
 min. L 85 x P 50 cm

P. 369

L. max. 226 con **VASCA CENTRALE**. Base min. L 85.

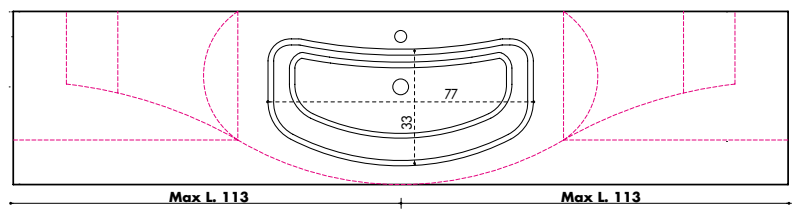

Art. F802

Per basi portalavabo
 min. L 85 x P 50 cm

P. 369



Slim

Piani top sp. 3,5 cm (con foro troppo pieno e set da installare)
Th. 3,5 cm tops (with overflow and set to be installed)
Plan de toilette H 3,5 cm (avec trop-plein et kit à installer)

Mineralguss / mineralguss / mineralguss
Vasca L 70 x P 35 x H 14 cm / interior W70 x D 35 x H 14 cm /
vasque int. L 70 x P 35 x H 14 cm

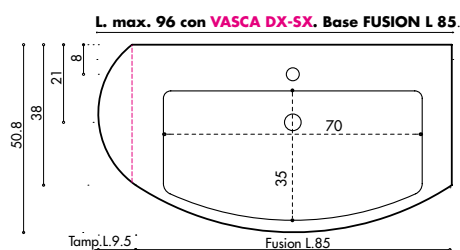

Art. F309
Per basi portalavabo
Fusion L 85 cm
P. 368

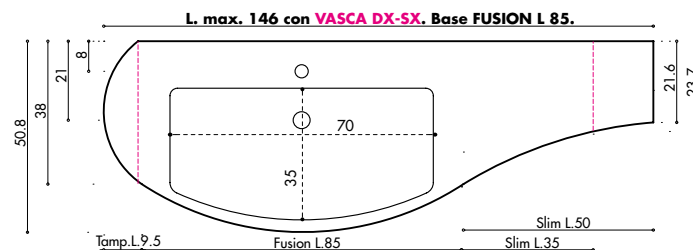

Art. F308
Per basi portalavabo
Fusion L 85 cm
P. 368



Zero

Piano top sp. 2,3 cm (con foro troppo pieno e set da installare)
Th. 2,3 cm tops (with overflow and set to be installed)
Plan de toilette H 2,3 cm (avec trop-plein et kit à installer)

Mineralguss / mineralguss / mineralguss
Vasca L 70 x P 35 x H 14 cm / interior W 70 x D 35 x H 14 cm /
vasque int. L 70 x P 35 x H 14 cm

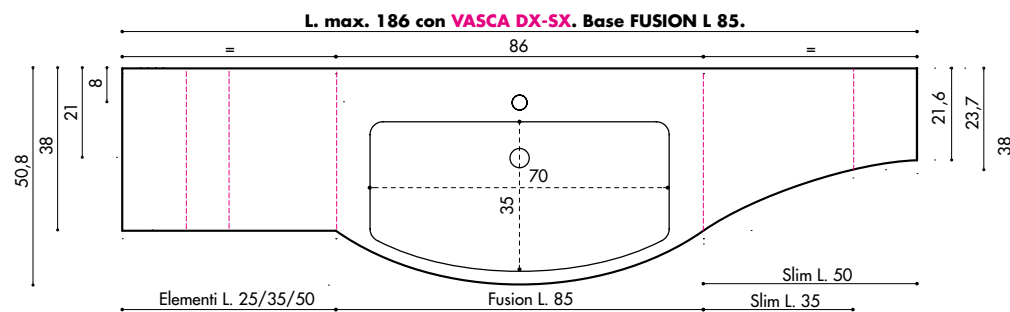

Art. F002
Per basi portalavabo
Fusion L 85 cm
P. 368



Rodi

Piani top sp. 1,2 cm (senza foro troppo pieno)
Th. 1,2 cm top (without overflow)
Plan de toilette H 1,2 cm (sans trop-plein)

Per basi portalavabo min. L 70 x P 50 cm /
for washbasin units min. W 70 x D 50 cm /
base lavabo L 70 x P 50 cm

Mineralguss / mineralguss / mineralguss
Vasca L 60 x P 30 x H 8 cm / interior W 60 x D 30 x H 8 cm /
vasque int. L 60 x P 30 x H 8 cm

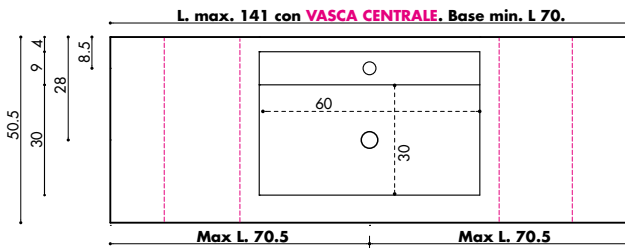

Art. **F294** - P. 370

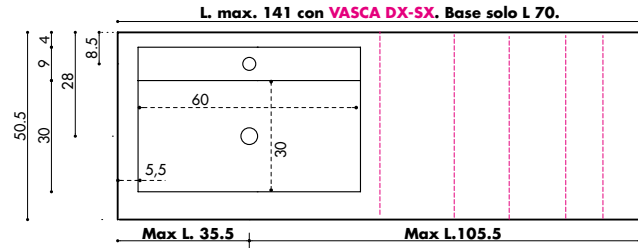

Art. **F295** - P. 370



Naxos

Piani top sp. 1,2 cm (senza foro troppo pieno)
Th. 1,2 cm top (without overflow)
Plan de toilette H 1,2 cm (sans trop-plein)

Per basi portalavabo min. L 70 x P 50 cm /
for washbasin units min. W 70 x D 50 cm /
pour éléments bas sous- lavabo L 70 x P 50 cm

Vasca L 60 x P 31 x H 10 cm / interior W 60 x D 31 x H 10 cm /
vasque int. L 60 x P 31 x H 10 cm

Finiture / finishes / finitions:

tekno

mineralguss



bianco



bianco

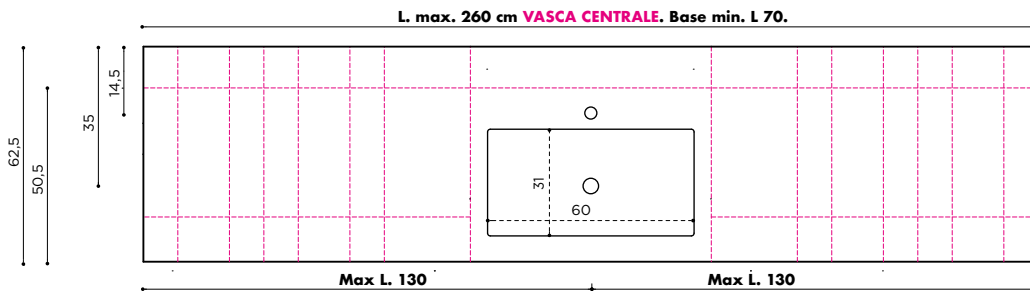

Art. **F372** - P. 370

Per mobile da L 70 a 105 cm

Art. **F373** - P. 370

Per mobile da L 106 a 140 cm

Art. **F374** - P. 370

Per mobile da L 141 a 170 cm

Art. **F375** - P. 370

Per mobile da L 171 a 190 cm

Art. **F376** - P. 370

Per mobile da L 191 a 220 cm

Art. **F377** - P. 370

Per mobile da L 221 a 260 cm





Small

Piani top sp. 1,2, 8 e 12,2 cm (senza foro troppo pieno)
 Th. 1,2, 8 and 12,2 cm top (without overflow)
 Plan de toilette H 1,2, 8 et 12,2 cm (sans trop-plein)

Per basi portalavabo min. L 60 x P 37 cm /
 for washbasin units min. W 60 x D 37 cm /
 élément bas sous-lavabo L 60 x P 37 cm

Vasca L 52 x P 24,5 x H 11 cm / interior W 52 x D 24,5 x H 11 cm /
 vasque int. L 52 x P 24,5 x H 11 cm

Finiture / finishes / finitions:

mineralguss:



bianco

tekno:



bianco

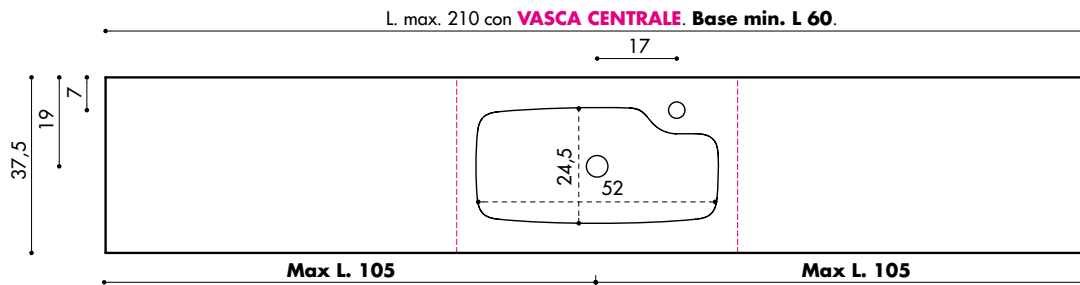



Small **sp. 1,2 cm**

Piani top sp. 1,2 cm (senza foro troppo pieno)
Th. 1,2 cm top (without overflow)
Plan de toilette H 1,2 cm (sans trop-plein)

Vasca L 52 x P 24,5 x H 11 cm / interior W 52 x D 24,5 x H 11 cm / vasque int. L 52 x P 24,5 x H 11 cm

vasca singola
one sink / 1 vasque

Art. **F012** - P. 372
Per mobile da L 60 a 105 cm

Art. **F013** - P. 372
Per mobile da L 106 a 140 cm

Art. **F014** - P. 372
Per mobile da L 141 a 170 cm

Art. **F015** - P. 372
Per mobile da L 171 a 190 cm

Art. **F016** - P. 372
Per mobile da L 191 a 210 cm

vasca doppia
twin sink / double vasque

Art. **F017** - P. 287
Per mobile da L 120 a 170 cm

Art. **F018** - P. 287
Per mobile da L 171 a 190 cm

Art. **F019** - P. 287
Per mobile da L 191 a 210 cm



Small **sp. 8 cm**

Piani top sp. 8 cm (senza foro troppo pieno)
Th. 8 cm top (without overflow)
Plan de toilette H 8 cm (sans trop-plein)

Vasca L 52 x P 24,5 x H 11 cm / interior W 52 x D 24,5 x H 11 cm / vasque int. L 52 x P 24,5 x H 11 cm

vasca singola
one sink / 1 vasque

Art. **F820** - P. 372
Per mobile da L 70 a 105 cm

Art. **F821** - P. 372
Per mobile da L 106 a 140 cm

Art. **F822** - P. 372
Per mobile da L 141 a 170 cm

Art. **F823** - P. 372
Per mobile da L 171 a 190 cm

Art. **F824** - P. 372
Per mobile da L 191 a 210 cm

vasca doppia
twin sink / double vasque

Art. **F825** - P. 372
Per mobile da L 140 a 170 cm

Art. **F826** - P. 372
Per mobile da L 171 a 190 cm

Art. **F827** - P. 372
Per mobile da L 191 a 210 cm

ATTENZIONE! I piani top sp. 8 cm vanno sempre impiegati in appoggio dal momento che l'altezza della vasca supera lo spessore del piano / **NOTE!** The tops 8 cm thick must always be used as countertops when the height of the basin exceeds the depth of the top / **ATTENTION!** Les plans de toilette ép. 8 cm doivent toujours être posés quand la hauteur de la vasque dépasse l'épaisseur du plan.



Small **sp. 12,2 cm**

Piani top sp. 12,2 cm (senza foro troppo pieno)
Th. 12,2 cm top (without overflow)
Plan de toilette H 12,2 cm (sans trop-plein)

Vasca L 52 x P 24,5 x H 11 cm / interior W 52 x D 24,5 x H 11 cm / vasque int. L 52 x P 24,5 x H 11 cm

vasca singola
one sink / 1 vasque

Art. **F020** - P. 372
Per mobile da L 70 a 105 cm

Art. **F021** - P. 372
Per mobile da L 106 a 140 cm

Art. **F022** - P. 372
Per mobile da L 141 a 170 cm

Art. **F023** - P. 372
Per mobile da L 171 a 190 cm

Art. **F024** - P. 372
Per mobile da L 191 a 210 cm

vasca doppia
twin sink / double vasque

Art. **F025** - P. 372
Per mobile da L 140 a 170 cm

Art. **F026** - P. 372
Per mobile da L 171 a 190 cm

Art. **F027** - P. 372
Per mobile da L 191 a 210 cm



Plug

Piani top sp. 1,2, 8 e 12,2 cm (senza foro troppo pieno)
Th. 1,2, 8 and 12,2 cm top (without overflow)
Plan de toilette H 1,2, 8 et 12,2 cm (sans trop-plein)

Per basi portalavabo min. L 60 x P 50 cm (per sp. 1,2 cm)
L 70 x P 50 cm (per sp. 8 e 12,2 cm) /
for washbasin units min. W 60 x D 50 cm (for 1,2 cm th.)
W 70 x D 50 cm (for 8 and 12,2 cm th.) /
Meuble S/lavabo L 60 x P 50 cm (pour ep. 1,2 cm)
L 70 x P 50 cm (pour 8 et 12,2 cm)

Vasca L 50 x P 31 x H 10 cm
interior W 50 x D 31 x H 10 cm
vasque int. L 50 x P 31 x H 10 cm

Finiture / finishes / finitions:

mineralguss:



bianco

tekno:



bianco

Stopper

Piani top sp. 1,2, 8 e 12,2 cm (senza foro troppo pieno)
Th. 1,2, 8 and 12,2 cm top (without overflow)
Plan de toilette H 1,2, 8 et 12,2 cm (sans trop-plein)

Per basi portalavabo min. L 85 x P 50 cm /
for washbasin units min. W 85 x D 50 cm /
meuble s/lavabo L 85 x P 50 cm

Vasca L 70 x P 31 x H 10 cm
interior W 70 x D 31 x H 10 cm
vasque int. 70 x P 31 x H 10 cm

Finiture / finishes / finitions:

mineralguss:



bianco

tekno:



bianco

PLUG - STOPPER:

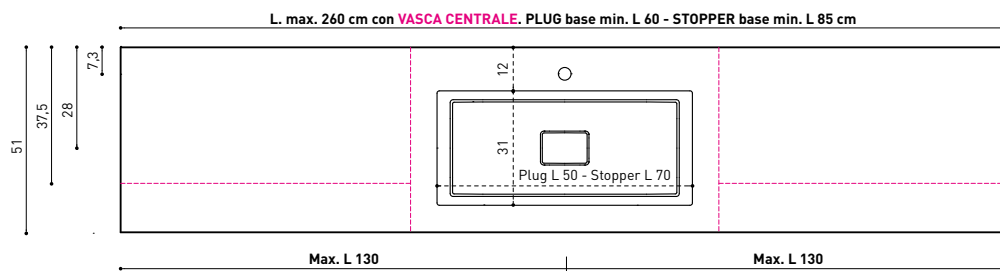

Plug **sp. 1,2 cm**

vasca singola
one sink / 1 vasque

Art. **F961** - p. 373
Per mobile da L 60 a 105 cm

Art. **F962** - p. 373
Per mobile da L 106 a 140 cm

Art. **F963** - p. 373
Per mobile da L 141 a 170 cm

Art. **F964** - p. 373
Per mobile da L 171 a 190 cm

Art. **F965** - p. 373
Per mobile da L 191 a 220 cm

Art. **F966** - p. 373
Per mobile da L 221 a 260 cm

vasca doppia
twin sink / double vasque

Art. **F967** - p. 373
Per mobile da L 120 a 170 cm

Art. **F968** - p. 373
Per mobile da L 171 a 190 cm

Art. **F969** - p. 373
Per mobile da L 191 a 220 cm

Art. **F970** - p. 373
Per mobile da L 221 a 260 cm

Stopper **sp. 1,2 cm**

vasca singola
one sink / 1 vasque

Art. **F971** - p. 373
Per mobile da L 85 a 105 cm

Art. **F972** - p. 373
Per mobile da L 106 a 140 cm

Art. **F973** - p. 373
Per mobile da L 141 a 170 cm

Art. **F974** - p. 373
Per mobile da L 171 a 190 cm

Art. **F975** - p. 373
Per mobile da L 191 a 220 cm

Art. **F976** - p. 373
Per mobile da L 221 a 260 cm

vasca doppia
twin sink / double vasque

Art. **F977** - p. 373
Per mobile L 170 cm

Art. **F978** - p. 373
Per mobile da L 171 a 190 cm

Art. **F979** - p. 373
Per mobile da L 191 a 220 cm

Art. **F980** - p. 373
Per mobile da L 221 a 260 cm

Plug **sp. 8 cm**

ATTENZIONE! I piani top sp. 8 cm vanno sempre impiegati in appoggio dal momento che l'altezza della vasca supera lo spessore del piano / **NOTE!** The tops 8 cm thick must always be used as countertops when the height of the basin exceeds the depth of the top / **ATTENTION!** Les plans de toilette ép. 8 cm doivent toujours être posés cal la hauteur de la vasque dépasse l'épaisseur du plan.

vasca singola
one sink / 1 vasque

Art. **F981** - p. 373
Per mobile da L 70 a 105 cm

Art. **F982** - p. 373
Per mobile da L 106 a 140 cm

Art. **F983** - p. 373
Per mobile da L 141 a 170 cm

Art. **F984** - p. 373
Per mobile da L 171 a 190 cm

Art. **F985** - p. 373
Per mobile da L 191 a 220 cm

Art. **F986** - p. 373
Per mobile da L 221 a 260 cm

vasca doppia
twin sink / double vasque

Art. **F987** - p. 373
Per mobile da L 140 a 170 cm

Art. **F988** - p. 373
Per mobile da L 171 a 190 cm

Art. **F989** - p. 373
Per mobile da L 191 a 220 cm

Art. **F990** - p. 373
Per mobile da L 221 a 260 cm

Stopper **sp. 8 cm**

ATTENZIONE! I piani top sp. 8 cm vanno sempre impiegati in appoggio dal momento che l'altezza della vasca supera lo spessore del piano / **NOTE!** The tops 8 cm thick must always be used as countertops when the height of the basin exceeds the depth of the top / **ATTENTION!** Les plans de toilette ép. 8 cm doivent toujours être posés cal la hauteur de la vasque dépasse l'épaisseur du plan.

vasca singola
one sink / 1 vasque

Art. **F991** - p. 373
Per mobile da L 85 a 105 cm

Art. **F992** - p. 373
Per mobile da L 106 a 140 cm

Art. **F993** - p. 373
Per mobile da L 141 a 170 cm

Art. **F994** - p. 373
Per mobile da L 171 a 190 cm

Art. **F995** - p. 373
Per mobile da L 191 a 220 cm

Art. **F996** - p. 373
Per mobile da L 221 a 260 cm

vasca doppia
twin sink / double vasque

Art. **F997** - p. 373
Per mobile L 170 cm

Art. **F998** - p. 373
Per mobile da L 171 a 190 cm

Art. **F999** - p. 373
Per mobile da L 191 a 220 cm

Art. **F000** - p. 373
Per mobile da L 221 a 260 cm

Plug **sp. 12,2 cm**

vasca singola
one sink / 1 vasque

Art. **F870** - p. 373
Per mobile da L 70 a 105 cm

Art. **F871** - p. 373
Per mobile da L 106 a 140 cm

Art. **F872** - p. 373
Per mobile da L 141 a 170 cm

Art. **F873** - p. 373
Per mobile da L 171 a 190 cm

Art. **F874** - p. 373
Per mobile da L 191 a 220 cm

Art. **F875** - p. 373
Per mobile da L 221 a 260 cm

vasca doppia
twin sink / double vasque

Art. **F876** - p. 373
Per mobile da L 140 a 170 cm

Art. **F877** - p. 373
Per mobile da L 171 a 190 cm

Art. **F878** - p. 373
Per mobile da L 191 a 220 cm

Art. **F879** - p. 373
Per mobile da L 221 a 260 cm

vasca singola
one sink / 1 vasque

Art. **F880** - p. 373
Per mobile da L 85 a 105 cm

Art. **F881** - p. 373
Per mobile da L 106 a 140 cm

Art. **F882** - p. 373
Per mobile da L 141 a 170 cm

Art. **F883** - p. 373
Per mobile da L 171 a 190 cm

Art. **F884** - p. 373
Per mobile da L 191 a 220 cm

Art. **F885** - p. 373
Per mobile da L 221 a 260 cm

vasca doppia
twin sink / double vasque

Art. **F886** - p. 373
Per mobile L 170 cm

Art. **F887** - p. 373
Per mobile da L 171 a 190 cm

Art. **F888** - p. 373
Per mobile da L 191 a 220 cm

Art. **F889** - p. 373
Per mobile da L 221 a 260 cm

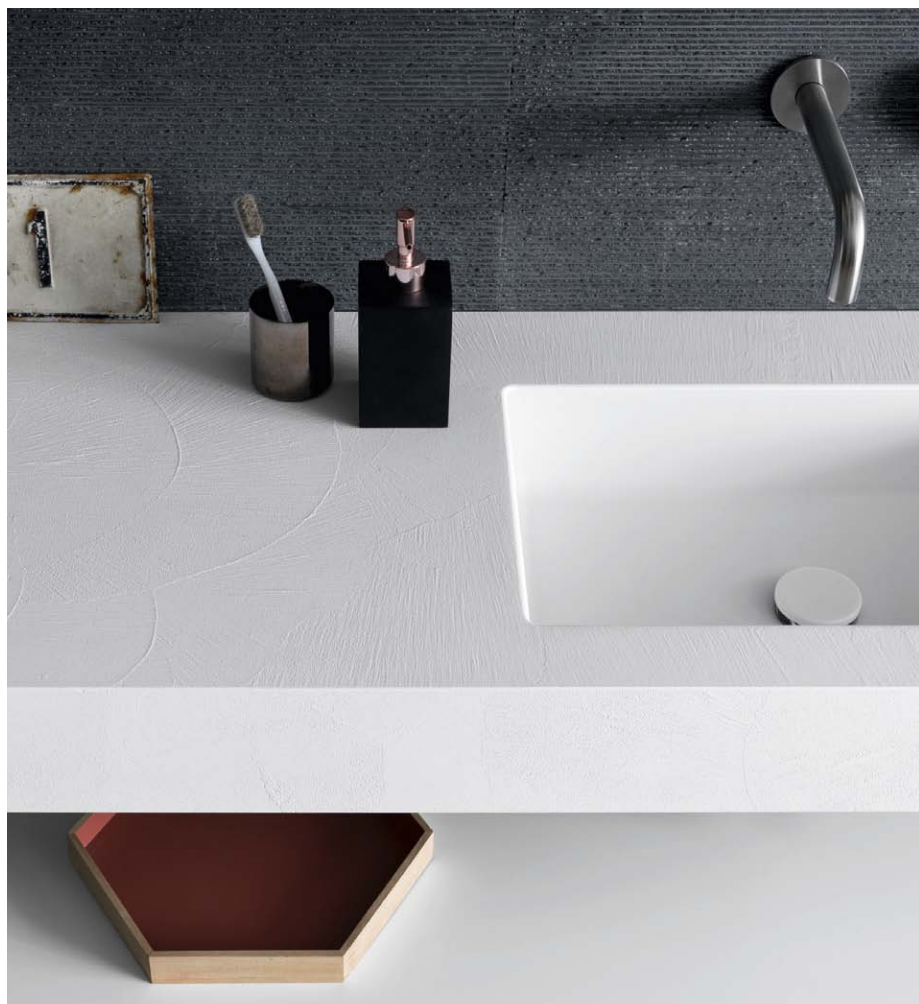

Wall 50

Piani top sp. 1,2, 8 e 14 cm (senza foro troppo pieno)
Th. 1,2, 8 and 14 cm top (without overflow)
Plan de toilette H 1,2, 8 et 14 cm (sans trop-plein)

Per basi portalavabo min. L 60 x P 50 cm (per sp. 1,2 cm)
L 70 x P 50 cm (per sp. 8 e 14 cm) /
for washbasin units min. W 60 x D 50 cm (for 1,2 cm th.)
W 70 x D 50 cm (for 8 and 14 cm th.) /
Meuble S/lavabo L 60 x P 50 cm (pour ep. 1,2 cm)
L 70 x P 50 cm (pour 8 et 14 cm)

Vasca L 50 x P 31 x H 11 cm
interior W 50 x D 31 x H 11 cm
vasque int. L 50 x P 31 x H 11 cm

Finiture / finishes / finitions:

tekno resina:



bianco tortora cemento

Wall 60

Piani top sp. 1,2, 8 e 14 cm (senza foro troppo pieno)
Th. 1,2, 8 and 12,2 cm top (without overflow)
Plan de toilette H 1,2, 8 et 12,2 cm (sans trop-plein)

Per basi portalavabo min. L 70 x P 50 cm (per sp. 1,2 cm)
L 85 x P 50 cm (per sp. 8 e 14 cm) /
for washbasin units min. W 70 x D 50 cm (for 1,2 cm th.)
W 85 x D 50 cm (for 8 and 14 cm th.) /
Meuble S/lavabo L 70 x P 50 cm (pour ep. 1,2 cm)
L 85 x P 50 cm (pour 8 et 14 cm)

Vasca L 60 x P 31 x H 11 cm
interior W 60 x D 31 x H 11 cm
vasque int. 60 x P 31 x H 11 cm

Finiture / finishes / finitions:

tekno resina:



bianco tortora cemento

ATTENZIONE! L'interno della vasca dei piani top Wall è liscio.
ATTENTION! The basin in the Wall tops is smooth.
ATTENTION! La vasque des plans de toilette Wall est lisse.

WALL 50

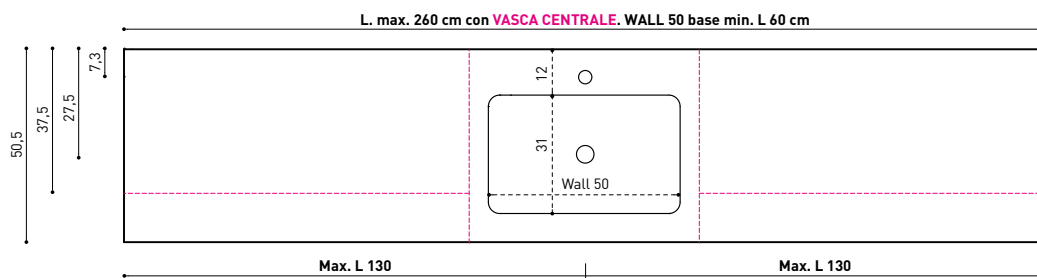

WALL 60

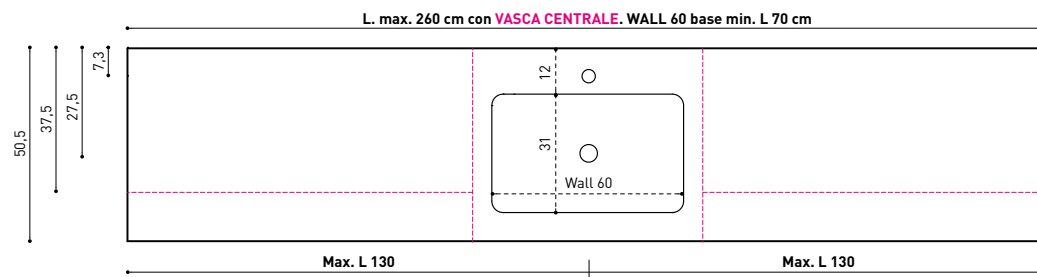

Wall 50 sp. 1,2 cm

vasca singola
one sink / 1 vasque

Art. **F901** - p. 374
Per mobile da L 60 a 105 cm

Art. **F902** - p. 374
Per mobile da L 106 a 140 cm

Art. **F903** - p. 374
Per mobile da L 141 a 170 cm

Art. **F904** - p. 374
Per mobile da L 171 a 190 cm

Art. **F905** - p. 374
Per mobile da L 191 a 220 cm

Art. **F906** - p. 374
Per mobile da L 221 a 260 cm

vasca doppia
twin sink / double vasque

Art. **F907** - p. 374
Per mobile da L 120 a 170 cm

Art. **F908** - p. 374
Per mobile da L 171 a 190 cm

Art. **F909** - p. 374
Per mobile da L 191 a 220 cm

Art. **F910** - p. 374
Per mobile da L 221 a 260 cm

Wall 60 sp. 1,2 cm

vasca singola
one sink / 1 vasque

Art. **F911** - p. 375
Per mobile da L 70 a 105 cm

Art. **F912** - p. 375
Per mobile da L 106 a 140 cm

Art. **F913** - p. 375
Per mobile da L 141 a 170 cm

Art. **F914** - p. 375
Per mobile da L 171 a 190 cm

Art. **F915** - p. 375
Per mobile da L 191 a 220 cm

Art. **F916** - p. 375
Per mobile da L 221 a 260 cm

vasca doppia
twin sink / double vasque

Art. **F917** - p. 375
Per mobile da L 140 a 170 cm

Art. **F918** - p. 375
Per mobile da L 171 a 190 cm

Art. **F919** - p. 375
Per mobile da L 191 a 220 cm

Art. **F920** - p. 375
Per mobile da L 221 a 260 cm

Wall 50 sp. 8 cm

ATTENZIONE! I piani top sp. 8 cm vanno sempre impiegati in appoggio dal momento che l'altezza della vasca supera lo spessore del piano / **NOTE!** The tops 8 cm thick must always be used as countertops when the height of the basin exceeds the depth of the top / **ATTENTION!** Les plans de toilette ép. 8 cm doivent toujours être posés cal la hauteur de la vasque dépasse l'épaisseur du plan.

vasca singola
one sink / 1 vasque

Art. **F921** - p. 374
Per mobile da L 70 a 105 cm

Art. **F922** - p. 374
Per mobile da L 106 a 140 cm

Art. **F923** - p. 374
Per mobile da L 141 a 170 cm

Art. **F924** - p. 374
Per mobile da L 171 a 190 cm

Art. **F925** - p. 374
Per mobile da L 191 a 220 cm

Art. **F926** - p. 374
Per mobile da L 221 a 260 cm

vasca doppia
twin sink / double vasque

Art. **F927** - p. 374
Per mobile da L 140 a 170 cm

Art. **F928** - p. 374
Per mobile da L 171 a 190 cm

Art. **F929** - p. 374
Per mobile da L 191 a 220 cm

Art. **F930** - p. 374
Per mobile da L 221 a 260 cm

Wall 60 sp. 8 cm

ATTENZIONE! I piani top sp. 8 cm vanno sempre impiegati in appoggio dal momento che l'altezza della vasca supera lo spessore del piano / **NOTE!** The tops 8 cm thick must always be used as countertops when the height of the basin exceeds the depth of the top / **ATTENTION!** Les plans de toilette ép. 8 cm doivent toujours être posés cal la hauteur de la vasque dépasse l'épaisseur du plan.

vasca singola
one sink / 1 vasque

Art. **F931** - p. 375
Per mobile da L 75 a 105 cm

Art. **F932** - p. 375
Per mobile da L 106 a 140 cm

Art. **F933** - p. 375
Per mobile da L 141 a 170 cm

Art. **F934** - p. 375
Per mobile da L 171 a 190 cm

Art. **F935** - p. 375
Per mobile da L 191 a 220 cm

Art. **F936** - p. 375
Per mobile da L 221 a 260 cm

vasca doppia
twin sink / double vasque

Art. **F937** - p. 375
Per mobile da L 150 a 170 cm

Art. **F938** - p. 375
Per mobile da L 171 a 190 cm

Art. **F939** - p. 375
Per mobile da L 191 a 220 cm

Art. **F940** - p. 375
Per mobile da L 221 a 260 cm

Wall 50 sp. 14 cm

vasca singola
one sink / 1 vasque

Art. **F941** - p. 374
Per mobile da L 70 a 105 cm

Art. **F942** - p. 374
Per mobile da L 106 a 140 cm

Art. **F943** - p. 374
Per mobile da L 141 a 170 cm

Art. **F944** - p. 374
Per mobile da L 171 a 190 cm

Art. **F945** - p. 374
Per mobile da L 191 a 220 cm

Art. **F946** - p. 374
Per mobile da L 221 a 260 cm

vasca doppia
twin sink / double vasque

Art. **F947** - p. 374
Per mobile da L 140 a 170 cm

Art. **F948** - p. 374
Per mobile da L 171 a 190 cm

Art. **F949** - p. 374
Per mobile da L 191 a 220 cm

Art. **F950** - p. 374
Per mobile da L 221 a 260 cm

Wall 60 sp. 14 cm

vasca singola
one sink / 1 vasque

Art. **F951** - p. 375
Per mobile da L 75 a 105 cm

Art. **F952** - p. 375
Per mobile da L 106 a 140 cm

Art. **F953** - p. 375
Per mobile da L 141 a 170 cm

Art. **F954** - p. 375
Per mobile da L 171 a 190 cm

Art. **F955** - p. 375
Per mobile da L 191 a 220 cm

Art. **F956** - p. 375
Per mobile da L 221 a 260 cm

vasca doppia
twin sink / double vasque

Art. **F957** - p. 375
Per mobile da L 150 a 170 cm

Art. **F958** - p. 375
Per mobile da L 171 a 190 cm

Art. **F959** - p. 375
Per mobile da L 191 a 220 cm

Art. **F960** - p. 375
Per mobile da L 221 a 260 cm



Finiture / finishes / finitions **KUKI, PLAZA, SLOT, RIGA**

CATEGORIA 1

> MINERALGUSS



Mineralguss
MG bianco lucido

ATTENZIONE! Per la reale tonalità delle finiture, fare riferimento al campionario.
ATTENTION! For the actual shade of the finishes, refer to the samples.
ATTENTION! Pour la réelle finition, faire référence à l'échantillon.

CATEGORIA 3

> TEKNO > FENIX > HPL WOOD



Tekno
E1 bianco opaco

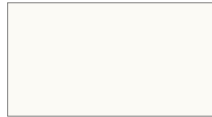

FENIX
F0 Bianco Kos



FENIX
F1 Grigio Efeso



FENIX
F2 Castoro Ottawa



FENIX
F3 Grigio Londra

FENIX ^{NTM}



FENIX
F4 Grigio Bromo



FENIX
F5 Bluriva



FENIX
F6 Verde Comodoro



FENIX
F7 Rosso Casale

ATTENZIONE!
Fenix e HPL Wood solo per Kuki e Plaza

ATTENTION!
Fenix and HPL Wood only for Kuki and Plaza

ATTENTION!
Fenix et HPL Wood uniquement pour Kuki et Plaza



HPL wood
FH Woody



HPL wood
FI Cayman



HPL wood
FJ Karbon

CATEGORIA 5

> LAMINAM > STEEL

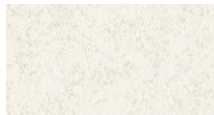

Laminam
A9 Oxide Bianco

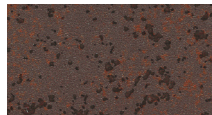

Laminam
A5 Oxide Moro



Laminam
A4 Oxide Nero

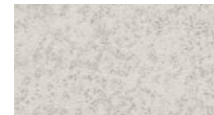

Laminam
AT Oxide Perla



Laminam
AU Oxide Grigio



Laminam
AF Pietra di Savoia Perla



Laminam
AE Pietra di Savoia Grigia

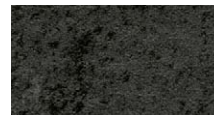

Laminam
AG Pietra di Savoia Antracite



Laminam
A0 Ossidiana Vena Grigia



Laminam
A8 Ossidiana Vena Scura

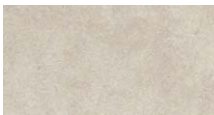

Laminam
AA Fokos Sale



Laminam
AC Fokos Terra



Laminam
AB Fokos Roccia



Laminam
AD Fokos Piombo



Laminam
AH Emperador

ATTENZIONE!
Steel solo per Kuki e Plaza

ATTENTION!
Steel only for Kuki and Plaza

ATTENTION!
Steel uniquement pour Kuki et Plaza

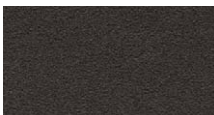

Steel
FM Textura

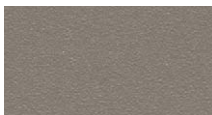

Steel
FN Sabbia



Steel
FO Ruggine



Steel
FQ Ulloa

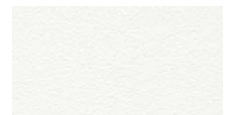

Steel
FP Bianco

Finiture / finishes / finitions **KUKI, PLAZA, SLOT, RIGA**

CATEGORIA 6

> LAMINAM
> GRES

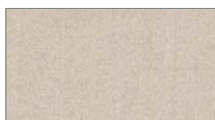

GRES
AJ Iris Ivory



GRES
AK Iris Plumb



GRES
AL Iris Silver

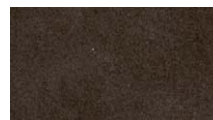

GRES
AM Iris Amber

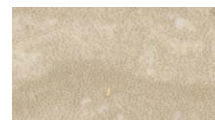

GRES
AQ Florim Travertino



GRES
AS Florim Amani opaco

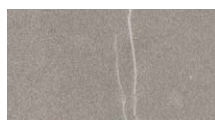

GRES
AR Florim Amani lucido

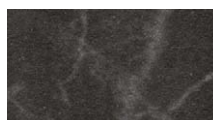

LAMINAM
AI Nero Greco opaco



LAMINAM
AV Pietra Grey opaco

CATEGORIA 7

> LAMINAM
> GRES



GRES
AP Iris Gaudi Stone lucido



GRES
AN Iris Calacatta opaco



GRES
AO Iris Bianco Venato op.

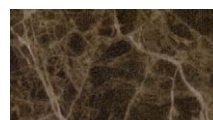

LAMINAM
AW Emperador extra luc.



LAMINAM
AX Statuarietto opaco



LAMINAM
AY Noir Desir lucido

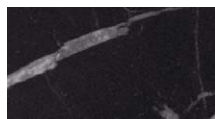

GRES
AZ Iris Black Marquinia



LAMINAM
DO Bianco Assoluto opaco

ATTENZIONE!

I piani top in Florim Travertino e Florim Amani hanno una lunghezza max di L 240 cm.

ATTENTION!

Tops in Florim Travertino and Florim Amani are max. W. 240 cm.

ATTENTION!

Les plans en Florim Travertino et Florim Amani ont longueur max de L 240 cm.





Kuki e Plaza

Piani top sp. 1,2, 8 e 12,2 cm (senza foro troppo pieno)
 Th. 1,2, 8 and 12,2 cm tops (without overflow)
 Plan de toilette H 1,2, 8 et 12,2 cm (sans trop-plein)

KUKI:

Vasca L 50 x P 31 x H 10 cm
 interior W 50 x D 31 x H 10 cm
 vasque int. L 50 x P 31 x H 10 cm

Per basi portalavabo min. L 60 x P 50 cm (per sp. 1,2 cm)
 L 70 x P 50 cm (per sp. 8 e 12,2 cm) /
 for washbasin units min. W 60 x D 50 cm (for 1,2 cm th.)
 W 70 x D 50 cm (for 8 and 12,2 cm th.) /
 Meuble S/lavabo L 60 x P 50 cm (pour ep. 1,2 cm)
 L 70 x P 50 cm (pour 8 et 12,2 cm)

PLAZA:

Vasca L 70 x P 31 x H 10 cm
 interior W 70 x D 31 x H 10 cm
 vasque int. 70 x P 31 x H 10 cm

Per basi portalavabo min. L 85 x P 50 cm /
 for washbasin units min. W 85 x D 50 cm /
 meuble s/lavabo L 85 x P 50 cm

KUKI:

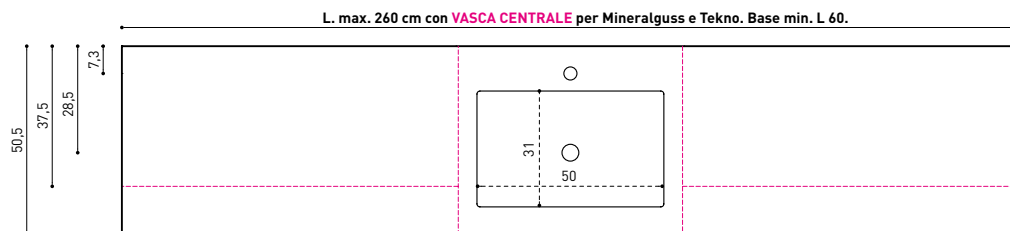

PLAZA:

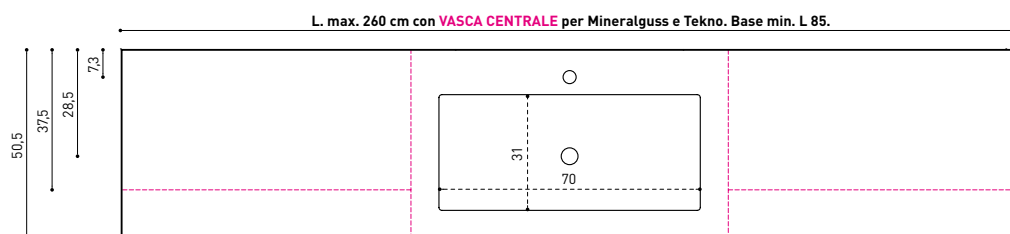



Kuki sp. 1,2 cm

Piani top sp. 1,2 cm (senza foro troppo pieno)
Th. 1,2 cm tops (without overflow)
Plan de toilette H 1,2 cm (sans trop-plein)

Vasca L 50 x P 31 x H 10 cm / interior W 50 x D 31 x H 10 cm / vasque int. L 50 x P 31 x H 10 cm

vasca singola
one sink / 1 vasque

Art. **F667** - p. 379
Per mobile da L 60 a 105 cm

Art. **F668** - p. 379
Per mobile da L 106 a 140 cm

Art. **F669** - p. 379
Per mobile da L 141 a 170 cm

Art. **F670** - p. 379
Per mobile da L 171 a 190 cm

Art. **F671** - p. 379
Per mobile da L 191 a 220 cm

Art. **F672** - p. 379
Per mobile da L 221 a 260 cm

vasca doppia
twin sink / double vasque

Art. **F703** - p. 379
Per mobile da L 120 a 170 cm

Art. **F704** - p. 379
Per mobile da L 171 a 190 cm

Art. **F705** - p. 379
Per mobile da L 191 a 220 cm

Art. **F706** - p. 379
Per mobile da L 221 a 260 cm



Kuki sp. 8 cm

Piani top sp. 8 cm (senza foro troppo pieno)
Th. 8 cm tops (without overflow)
Plan de toilette H 8 cm (sans trop-plein)

Vasca L 50 x P 31 x H 10 cm / interior W 50 x D 31 x H 10 cm / vasque int. L 50 x P 31 x H 10 cm

vasca singola
one sink / 1 vasque

Art. **F267** - p. 379
Per mobile da L 70 a 105 cm

Art. **F268** - p. 379
Per mobile da L 106 a 140 cm

Art. **F269** - p. 379
Per mobile da L 141 a 170 cm

Art. **F270** - p. 379
Per mobile da L 171 a 190 cm

Art. **F271** - p. 379
Per mobile da L 191 a 220 cm

Art. **F272** - p. 379
Per mobile da L 221 a 260 cm

vasca doppia
twin sink / double vasque

Art. **F273** - p. 379
Per mobile da L 140 a 170 cm

Art. **F274** - p. 379
Per mobile da L 171 a 190 cm

Art. **F275** - p. 379
Per mobile da L 191 a 220 cm

Art. **F276** - p. 379
Per mobile da L 221 a 260 cm

ATTENZIONE! I piani top sp. 8 cm vanno sempre impiegati in appoggio dal momento che l'altezza della vasca supera lo spessore del piano / **NOTE!** The tops 8 cm thick must always be used as countertops when the height of the basin exceeds the depth of the top / **ATTENTION!** Les plans de toilette ép. 8 cm doivent toujours être posés car la hauteur de la vasque dépasse l'épaisseur du plan.



Kuki sp. 12,2 cm

Piani top sp. 12,2 cm (senza foro troppo pieno)
Th. 12,2 cm tops (without overflow)
Plan de toilette H 12,2 cm (sans trop-plein)

Vasca L 50 x P 31 x H 10 cm / interior W 50 x D 31 x H 10 cm / vasque int. L 50 x P 31 x H 10 cm

vasca singola
one sink / 1 vasque

Art. **F707** - p. 379
Per mobile da L 70 a 105 cm

Art. **F708** - p. 379
Per mobile da L 106 a 140 cm

Art. **F709** - p. 379
Per mobile da L 141 a 170 cm

Art. **F710** - p. 379
Per mobile da L 171 a 190 cm

Art. **F711** - p. 379
Per mobile da L 191 a 220 cm

Art. **F712** - p. 379
Per mobile da L 221 a 260 cm

vasca doppia
twin sink / double vasque

Art. **F627** - p. 379
Per mobile da L 140 a 170 cm

Art. **F628** - p. 379
Per mobile da L 171 a 190 cm

Art. **F629** - p. 379
Per mobile da L 191 a 220 cm

Art. **F630** - p. 379
Per mobile da L 221 a 260 cm



Plaza sp. 1,2 cm

Piani top sp. 1,2 cm (senza foro troppo pieno)
Th. 1,2 cm tops (without overflow)
Plan de toilette H 1,2 cm (sans trop-plein)

Vasca L 70 x P 31 x H 10 cm / interior W 70 x D 31 x H 10 cm / vasque int. L 70 x P 31 x H 10 cm

vasca singola
one sink / 1 vasque

Art. **F505** - P. 379
Per mobile da L 85 a 105 cm

Art. **F506** - P. 379
Per mobile da L 106 a 140 cm

Art. **F507** - P. 379
Per mobile da L 141 a 170 cm

Art. **F508** - P. 379
Per mobile da L 171 a 190 cm

Art. **F509** - P. 379
Per mobile da L 191 a 220 cm

Art. **F510** - P. 379
Per mobile da L 221 a 260 cm

vasca doppia
twin sink / double vasque

Art. **F617** - P. 379
Per mobile L 170 cm

Art. **F618** - P. 379
Per mobile da L 171 a 190 cm

Art. **F619** - P. 379
Per mobile da L 191 a 220 cm

Art. **F620** - P. 379
Per mobile da L 221 a 260 cm



Plaza sp. 8 cm

Piani top sp. 8 cm (senza foro troppo pieno)
Th. 8 cm tops (without overflow)
Plan de toilette H 8 cm (sans trop-plein)

Vasca L 70 x P 31 x H 10 cm / interior W 70 x D 31 x H 10 cm / vasque int. L 70 x P 31 x H 10 cm

vasca singola
one sink / 1 vasque

Art. **F466** - P. 379
Per mobile da L 85 a 105 cm

Art. **F467** - P. 379
Per mobile da L 106 a 140 cm

Art. **F468** - P. 379
Per mobile da L 141 a 170 cm

Art. **F469** - P. 379
Per mobile da L 171 a 190 cm

Art. **F470** - P. 379
Per mobile da L 191 a 220 cm

Art. **F471** - P. 379
Per mobile da L 221 a 260 cm

vasca doppia
twin sink / double vasque

Art. **F476** - P. 379
Per mobile L 170 cm

Art. **F473** - P. 379
Per mobile da L 171 a 190 cm

Art. **F474** - P. 379
Per mobile da L 191 a 220 cm

Art. **F475** - P. 379
Per mobile da L 221 a 260 cm

ATTENZIONE! I piani top sp. 8 cm vanno sempre impiegati in appoggio dal momento che l'altezza della vasca supera lo spessore del piano / **NOTE!** The tops 8 cm thick must always be used as countertops when the height of the basin exceeds the depth of the top / **ATTENTION!** Les plans de toilette ép. 8 cm doivent toujours être posés car la hauteur de la vasque dépasse l'épaisseur du plan.



Plaza sp. 12,2 cm

Piani top sp. 12,2 cm (senza foro troppo pieno)
Th. 12,2 cm tops (without overflow)
Plan de toilette H 12,2 cm (sans trop-plein)

Vasca L 70 x P 31 x H 10 cm / interior W 70 x D 31 x H 10 cm / vasque int. L 70 x P 31 x H 10 cm

vasca singola
one sink / 1 vasque

Art. **F713** - P. 379
Per mobile da L 85 a 105 cm

Art. **F714** - P. 379
Per mobile da L 106 a 140 cm

Art. **F715** - P. 379
Per mobile da L 141 a 170 cm

Art. **F716** - P. 379
Per mobile da L 171 a 190 cm

Art. **F717** - P. 379
Per mobile da L 191 a 220 cm

Art. **F718** - P. 379
Per mobile da L 221 a 260 cm

vasca doppia
twin sink / double vasque

Art. **F607** - P. 379
Per mobile L 170 cm

Art. **F608** - P. 379
Per mobile da L 171 a 190 cm

Art. **F609** - P. 379
Per mobile da L 191 a 220 cm

Art. **F610** - P. 379
Per mobile da L 221 a 260 cm



Slot e Riga

Piani top sp. 1,2, 8 e 12,2 cm (senza foro troppo pieno, con scarico ispezionabile)
Th. 1,2, 8 and 12,2 cm tops (without overflow. Drain can be inspected)
Plan de toilette H 1,2, 8 et 12,2 cm (sans trop-plein, avec évacuation contrôlable)

SLOT:

Vasca L 50 x P 31 x H 10 cm
interior W 50 x D 31 x H 10 cm
vasque int. L 50 x P 31 x H 10 cm

Per basi portlavabo min. L 60 x P 50 cm (per sp. 1,2 cm) - L 70 x P 50 cm (per sp. 8 e 12,2 cm) /
for washbasin units min. W 60 x D 50 cm (for 1,2 cm th.) - W 70 x D 50 cm (for 8 and 12,2 cm th.) /
meuble S/lavabo L 60 x P 50 cm (pour ep. 1,2 cm) /
L 70 x P 50 cm (pour 8 et 12,2 cm)

RIGA:

Vasca L 70 x P 31 x H 10 cm
interior W 70 x D 31 x H 10 cm
vasque int. 70 x P 31 x H 10 cm

Per basi portlavabo min. L 85 x P 50 cm /
for washbasin units min. W 85 x D 50 cm /
meuble S/lavabo L 85 x P 50 cm

Finiture / finishes / finitions:

Vedi pagg. 57-58

See pages 57-58

Voir pages 57-58

SLOT:

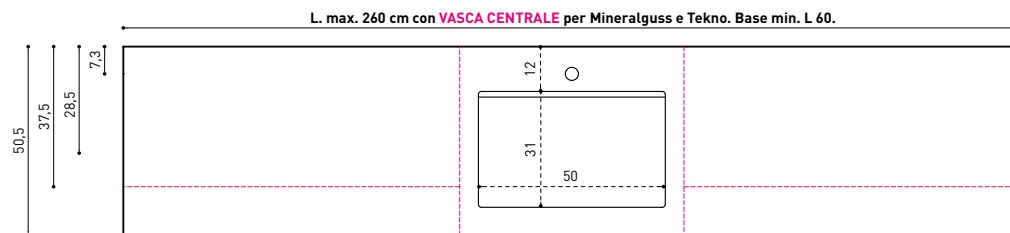

RIGA:

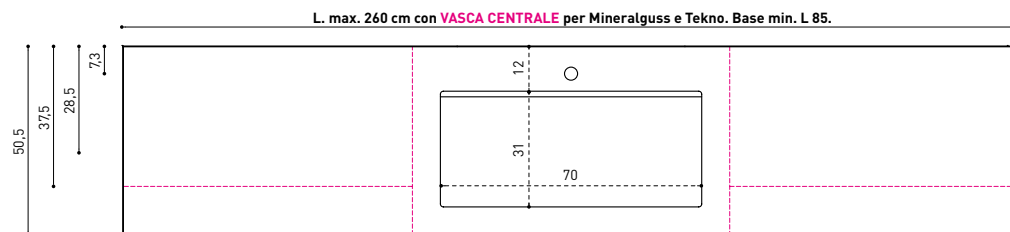



Slot sp. 1,2 cm

Piani top sp. 1,2 cm (senza foro troppo pieno)
Th. 1,2 cm tops (without overflow)
Plan de toilette H 1,2 cm (sans trop-plein)

Vasca L 50 x P 31 x H 10 cm / interior W 50 x D 31 x H 10 cm / vasque int. L 50 x P 31 x H 10 cm

vasca singola

Art. **A238** - P. 381
Per mobile da L 60 a 105 cm

Art. **A239** - P. 381
Per mobile da L 106 a 140 cm

Art. **A240** - P. 381
Per mobile da L 141 a 170 cm

Art. **A241** - P. 381
Per mobile da L 171 a 190 cm

Art. **A242** - P. 381
Per mobile da L 191 a 220 cm

Art. **A243** - P. 381
Per mobile da L 221 a 260 cm

vasca doppia

Art. **A244** - P. 381
Per mobile da L 120 a 170 cm

Art. **A245** - P. 381
Per mobile da L 171 a 190 cm

Art. **A246** - P. 381
Per mobile da L 191 a 220 cm

Art. **A247** - P. 381
Per mobile da L 221 a 260 cm



Slot sp. 8 cm

Piani top sp. 8 cm (senza foro troppo pieno)
Th. 8 cm tops (without overflow)
Plan de toilette H 8 cm (sans trop-plein)

Vasca L 50 x P 31 x H 10 cm / interior W 50 x D 31 x H 10 cm / vasque int. L 50 x P 31 x H 10 cm

vasca singola

Art. **F522** - P. 381
Per mobile da L 70 a 105 cm

Art. **F523** - P. 381
Per mobile da L 106 a 140 cm

Art. **F524** - P. 381
Per mobile da L 141 a 170 cm

Art. **F525** - P. 381
Per mobile da L 171 a 190 cm

Art. **F526** - P. 381
Per mobile da L 191 a 220 cm

Art. **F527** - P. 381
Per mobile da L 221 a 260 cm

vasca doppia

Art. **F528** - P. 381
Per mobile da L 140 a 170 cm

Art. **F529** - P. 381
Per mobile da L 171 a 190 cm

Art. **F530** - P. 381
Per mobile da L 191 a 220 cm

Art. **F531** - P. 381
Per mobile da L 221 a 260 cm

ATTENZIONE! I piani top sp. 8 cm vanno sempre impiegati in appoggio dal momento che l'altezza della vasca supera lo spessore del piano / **NOTE!** The 8 cm thick tops must always be used as countertops when the height of the basin exceeds the depth of the top / **ATTENTION!** Les plans de toilette ép. 8 cm doivent toujours être posés car la hauteur de la vasque dépasse l'épaisseur du plan.



Slot sp. 12,2 cm

Piani top sp. 12,2 cm (senza foro troppo pieno)
Th. 12,2 cm tops (without overflow)
Plan de toilette H 12,2 cm (sans trop-plein)

Vasca L 50 x P 31 x H 10 cm / interior W 50 x D 31 x H 10 cm / vasque int. L 50 x P 31 x H 10 cm

vasca singola

Art. **A248** - P. 381
Per mobile da L 70 a 105 cm

Art. **A249** - P. 381
Per mobile da L 106 a 140 cm

Art. **A250** - P. 381
Per mobile da L 141 a 170 cm

Art. **A251** - P. 381
Per mobile da L 171 a 190 cm

Art. **A252** - P. 381
Per mobile da L 191 a 220 cm

Art. **A253** - P. 381
Per mobile da L 221 a 260 cm

vasca doppia

Art. **A254** - P. 381
Per mobile da L 140 a 170 cm

Art. **A255** - P. 381
Per mobile da L 171 a 190 cm

Art. **A256** - P. 381
Per mobile da L 191 a 220 cm

Art. **A257** - P. 381
Per mobile da L 221 a 260 cm



Riga sp. 1,2 cm

Piani top sp. 1,2 cm (senza foro troppo pieno)
Th. 1,2 cm tops (without overflow)
Plan de toilette H 1,2 cm (sans trop-plein)

Vasca L 70 x P 31 x H 10 cm / interior W 70 x D 31 x H 10 cm / vasque int. L 70 x P 31 x H 10 cm

vasca singola

- Art. **A258** - P. 381
Per mobile da L 85 a 105 cm
- Art. **A259** - P. 381
Per mobile da L 106 a 140 cm
- Art. **A260** - P. 381
Per mobile da L 141 a 170 cm
- Art. **A261** - P. 381
Per mobile da L 171 a 190 cm
- Art. **A262** - P. 381
Per mobile da L 191 a 220 cm
- Art. **A263** - P. 381
Per mobile da L 221 a 260 cm

vasca doppia

- Art. **A264** - P. 381
Per mobile L 170 cm
- Art. **A265** - P. 381
Per mobile da L 171 a 190 cm
- Art. **A266** - P. 381
Per mobile da L 191 a 220 cm
- Art. **A267** - P. 381
Per mobile da L 221 a 260 cm



Riga sp. 8 cm

Piani top sp. 8 cm (senza foro troppo pieno)
Th. 8 cm tops (without overflow)
Plan de toilette H 8 cm (sans trop-plein)

Vasca L 70 x P 31 x H 10 cm / interior W 70 x D 31 x H 10 cm / vasque int. L 70 x P 31 x H 10 cm

vasca singola

- Art. **F532** - P. 381
Per mobile da L 85 a 105 cm
- Art. **F533** - P. 381
Per mobile da L 106 a 140 cm
- Art. **F534** - P. 381
Per mobile da L 141 a 170 cm
- Art. **F535** - P. 381
Per mobile da L 171 a 190 cm
- Art. **F536** - P. 381
Per mobile da L 191 a 220 cm
- Art. **F537** - P. 381
Per mobile da L 221 a 260 cm

vasca doppia

- Art. **F504** - P. 381
Per mobile L 170 cm
- Art. **F539** - P. 381
Per mobile da L 171 a 190 cm
- Art. **F540** - P. 381
Per mobile da L 191 a 220 cm
- Art. **F541** - P. 381
Per mobile da L 221 a 260 cm

ATTENZIONE! I piani top sp. 8 cm vanno sempre impiegati in appoggio dal momento che l'altezza della vasca supera lo spessore del piano / **NOTE!** The tops 8 cm thick must always be used as countertops when the height of the basin exceeds the depth of the top / **ATTENTION!** Les plans de toilette ép. 8 cm doivent toujours être posés car la hauteur de la vasque dépasse l'épaisseur du plan.



Riga sp. 12,2 cm

Piani top sp. 12,2 cm (senza foro troppo pieno)
Th. 12,2 cm tops (without overflow)
Plan de toilette H 12,2 cm (sans trop-plein)

Vasca L 70 x P 31 x H 10 cm / interior W 70 x D 31 x H 10 cm / vasque int. L 70 x P 31 x H 10 cm

vasca singola

- Art. **A268** - P. 381
Per mobile da L 85 a 105 cm
- Art. **A269** - P. 381
Per mobile da L 106 a 140 cm
- Art. **A270** - P. 381
Per mobile da L 141 a 170 cm
- Art. **A271** - P. 381
Per mobile da L 171 a 190 cm
- Art. **A272** - P. 381
Per mobile da L 191 a 220 cm
- Art. **A273** - P. 381
Per mobile da L 221 a 260 cm

vasca doppia

- Art. **F277** - P. 381
Per mobile L 170 cm
- Art. **A275** - P. 381
Per mobile da L 170 a 190 cm
- Art. **A276** - P. 381
Per mobile da L 191 a 220 cm
- Art. **A277** - P. 381
Per mobile da L 221 a 260 cm



Kuki e Plaza in **marmo** / marble / marbre

Piani top sp. 2 e 12,2 cm (senza foro troppo pieno)
Th. 2 and 12,2 cm tops (without overflow)
Plan de toilette H 2 et 12,2 cm (sans trop-plein)

KUKI:

Vasca L 50 x P 31 x H 10 cm
interior W 50 x D 31 x H 10 cm
vasque int. L 50 x P 31 x H 10 cm

Per basi portalavabo min. L 60 x P 50 cm /
for washbasin units min. W 60 x D 50 cm /
meuble s/lavabo L 60 x P 50 cm

PLAZA:

Vasca L 70 x P 31 x H 10 cm
interior W 70 x D 31 x H 10 cm
vasque int. 70 x P 31 x H 10 cm

Per basi portalavabo min. L 85 x P 50 cm /
for washbasin units min. W 85 x D 50 cm /
meuble s/lavabo L 85 x P 50 cm

Finiture / finishes / finitions:

marmo / marble / marbre CAT. A:

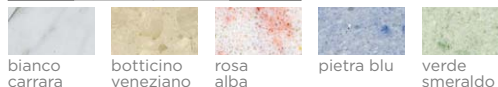

bianco carrara botticino veneziano rosa alba pietra blu verde smeraldo

marmo / marble / marbre CAT. B:



orient carbone light grey

marmo / marble / marbre CAT. C:

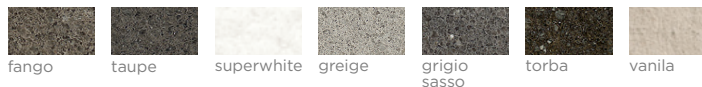

fango taupe superwhite greige grigio sasso torba vanila



merope doradus



Kuki sp. 2 cm in marmo / marble / marbre

vasca singola

Art. **F567** - P. 383
Per mobile da L 60 a 105 cm

Art. **F568** - P. 383
Per mobile da L 106 a 140 cm

Art. **F569** - P. 383
Per mobile da L 141 a 170 cm

Art. **F570** - P. 383
Per mobile da L 171 a 190 cm

Art. **F571** - P. 383
Per mobile da L 191 a 220 cm

Art. **F572** - P. 383
Per mobile da L 221 a 260 cm

vasca doppia

Art. **F307** - P. 383
Per mobile da L 120 a 170 cm

Art. **F304** - P. 383
Per mobile da L 171 a 190 cm

Art. **F305** - P. 383
Per mobile da L 191 a 220 cm

Art. **F306** - P. 383
Per mobile da L 221 a 260 cm



Kuki sp. 12,2 cm in marmo / marble / marbre

vasca singola

Art. **F107** - P. 383
Per mobile da L 70 a 105 cm

Art. **F108** - P. 383
Per mobile da L 106 a 140 cm

Art. **F109** - P. 383
Per mobile da L 141 a 170 cm

Art. **F110** - P. 383
Per mobile da L 171 a 190 cm

Art. **F111** - P. 383
Per mobile da L 191 a 220 cm

Art. **F112** - P. 383
Per mobile da L 221 a 260 cm

vasca doppia

Art. **F427** - P. 383
Per mobile da L 140 a 170 cm

Art. **F428** - P. 383
Per mobile da L 171 a 190 cm

Art. **F429** - P. 383
Per mobile da L 191 a 220 cm

Art. **F430** - P. 383
Per mobile da L 221 a 260 cm



Plaza sp. 2 cm in marmo / marble / marbre

vasca singola

Art. **F205** - P. 383
Per mobile da L 85 a 105 cm

Art. **F206** - P. 383
Per mobile da L 106 a 140 cm

Art. **F207** - P. 383
Per mobile da L 141 a 170 cm

Art. **F208** - P. 383
Per mobile da L 171 a 190 cm

Art. **F209** - P. 383
Per mobile da L 191 a 220 cm

Art. **F210** - P. 383
Per mobile da L 221 a 260 cm

vasca doppia

Art. **F617** - P. 383
Per mobile L 170 cm

Art. **F318** - P. 383
Per mobile da L 171 a 190 cm

Art. **F319** - P. 383
Per mobile da L 191 a 220 cm

Art. **F320** - P. 383
Per mobile da L 221 a 260 cm



Plaza sp. 12,2 cm in marmo / marble / marbre

vasca singola

Art. **F113** - P. 383
Per mobile da L 85 a 105 cm

Art. **F114** - P. 383
Per mobile da L 106 a 140 cm

Art. **F115** - P. 383
Per mobile da L 141 a 170 cm

Art. **F116** - P. 383
Per mobile da L 171 a 190 cm

Art. **F117** - P. 383
Per mobile da L 191 a 220 cm

Art. **F118** - P. 383
Per mobile da L 221 a 260 cm

vasca doppia

Art. **F607** - P. 383
Per mobile L 170 cm

Art. **F808** - P. 383
Per mobile da L 171 a 190 cm

Art. **F809** - P. 383
Per mobile da L 191 a 220 cm

Art. **F810** - P. 383
Per mobile da L 221 a 260 cm



Bob piccolo - Bob grande

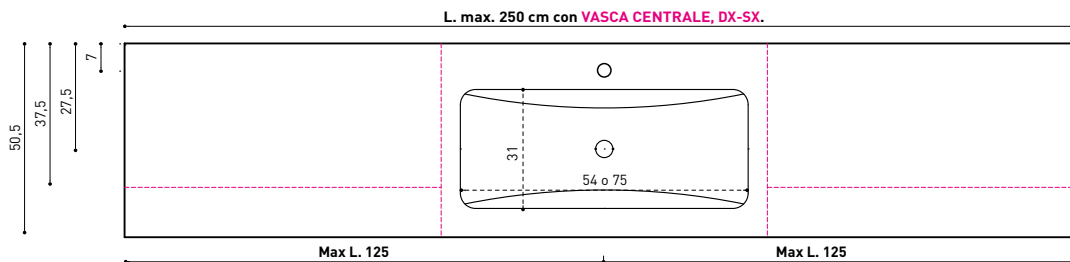

Bob piccolo

Piani top sp. 1,2 cm (senza foro troppo pieno)
Th. 1,2 cm tops (without overflow)
Plan de toilette H 1,2 cm (sans trop-plein)

Vasca L 54 x P 31 x H 12 cm / interior W 54 x D 31 x H 12 cm / vasque int. L 54 x P 31 x H 12 cm
Per basi portalavabo min. L 70 x P 50 cm / for washbasin units min. W 70 x D 50 cm / meuble S/lavabo L 70 x P 50 cm

Finiture / finishes / finitions:
corian:

vasca singola
one sink / 1 vasque

Art. **F828** - P. 385
Per mobile da L 70 a 105 cm

Art. **F829** - P. 385
Per mobile da L 106 a 140 cm

Art. **F830** - P. 385
Per mobile da L 141 a 175 cm

Art. **F831** - P. 385
Per mobile da L 176 a 190 cm

Art. **F832** - P. 385
Per mobile da L 191 a 220 cm

Art. **F833** - P. 385
Per mobile da L 221 a 250 cm

vasca doppia
twin sink / double vasque

Art. **F834** - P. 385
Per mobile da L 140 a 175 cm

Art. **F835** - P. 385
Per mobile da L 176 a 190 cm

Art. **F836** - P. 385
Per mobile da L 191 a 220 cm

Art. **F837** - P. 385
Per mobile da L 221 a 250 cm

DuPont™
CORIAN®
SOLID SURFACES

Bob grande

Piani top sp. 1,2 cm (senza foro troppo pieno)
Th. 1,2 cm tops (without overflow)
Plan de toilette H 1,2 cm (sans trop-plein)

Vasca L 75 x P 31 x H 12 cm / interior W 75 x D 31 x H 12 cm / vasque int. L 75 x P 31 x H 12 cm
Per basi portalavabo min. L 85 x P 50 cm / for washbasin units min. W 85 x D 50 cm / meuble S/lavabo L 85 x P 50 cm

Finiture / finishes / finitions:
corian:

vasca singola
one sink / 1 vasque

Art. **F838** - P. 385
Per mobile da L 85 a 105 cm

Art. **F839** - P. 385
Per mobile da L 106 a 140 cm

Art. **F840** - P. 385
Per mobile da L 141 a 175 cm

Art. **F841** - P. 385
Per mobile da L 176 a 190 cm

Art. **F842** - P. 385
Per mobile da L 191 a 220 cm

Art. **F843** - P. 385
Per mobile da L 221 a 250 cm

DuPont™
CORIAN®
SOLID SURFACES



Fly 50-60-70

Piani top sp. 1 cm (senza foro troppo pieno)
 Th. 1 cm tops (without overflow)
 Plan de toilette H 1 cm (sans trop-plein)

Finiture / finishes / finitions:

corian:



DuPont™
CORIAN®
 SOLID SURFACES

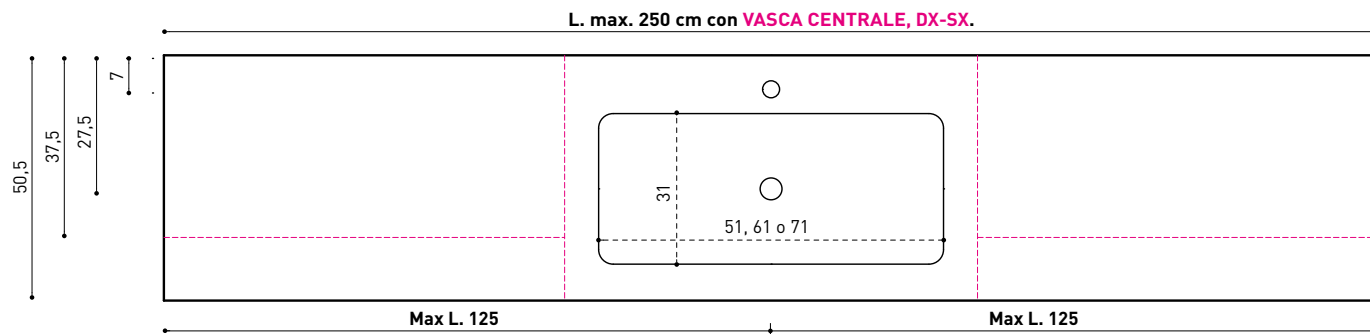

Fly 50

Piani top sp. 1 cm (senza foro troppo pieno)
Th. 1 cm tops (without overflow)
Plan de toilette H 1 cm (sans trop-plein)

Vasca L 51 x P 31 x H 9 cm / interior W 51 x D 31 x H 9 cm / vasque int. L 51 x P 31 x H 9 cm
Per basi portalavabo min. L 60 x P 50 cm / for washbasin units min. W 60 x D 50 cm / meuble S/lavabo
L 60 x P 50 cm

vasca singola

- Art. **F844** - p. 385
Per mobile da L 70 a 105 cm
- Art. **F845** - p. 385
Per mobile da L 106 a 140 cm
- Art. **F846** - p. 385
Per mobile da L 141 a 175 cm
- Art. **F847** - p. 385
Per mobile da L 176 a 190 cm
- Art. **F848** - p. 385
Per mobile da L 191 a 220 cm
- Art. **F849** - p. 385
Per mobile da L 221 a 250 cm

vasca doppia

- Art. **F850** - p. 385
Per mobile da L 140 a 175 cm
- Art. **F851** - p. 385
Per mobile da L 176 a 190 cm
- Art. **F852** - p. 385
Per mobile da L 191 a 220 cm
- Art. **F853** - p. 385
Per mobile da L 221 a 250 cm

Fly 60

Piani top sp. 1 cm (senza foro troppo pieno)
Th. 1 cm tops (without overflow)
Plan de toilette H 1 cm (sans trop-plein)

Vasca L 61 x P 31 x H 9 cm / interior W 61 x D 31 x H 9 cm / vasque int. L 61 x P 31 x H 9 cm
Per basi portalavabo min. L 70 x P 50 cm / for washbasin units min. W 70 x D 50 cm / meuble S/lavabo
L 70 x P 50 cm

vasca singola

- Art. **F854** - p. 385
Per mobile da L 70 a 105 cm
- Art. **F855** - p. 385
Per mobile da L 106 a 140 cm
- Art. **F856** - p. 385
Per mobile da L 141 a 175 cm
- Art. **F857** - p. 385
Per mobile da L 176 a 190 cm
- Art. **F858** - p. 385
Per mobile da L 191 a 220 cm
- Art. **F859** - p. 385
Per mobile da L 221 a 250 cm

vasca doppia

- Art. **F860** - p. 385
Per mobile da L 140 a 175 cm
- Art. **F861** - p. 385
Per mobile da L 176 a 190 cm
- Art. **F862** - p. 385
Per mobile da L 191 a 220 cm
- Art. **F863** - p. 385
Per mobile da L 221 a 250 cm

Fly 70

Piani top sp. 1 cm (senza foro troppo pieno)
Th. 1 cm tops (without overflow)
Plan de toilette H 1 cm (sans trop-plein)

Vasca L 71 x P 31 x H 9 cm / interior W 71 x D 31 x H 9 cm / vasque int. L 71 x P 31 x H 9 cm
Per basi portalavabo min. L 85 x P 50 cm / for washbasin units min. W 85 x D 50 cm / meuble S/lavabo
L 85 x P 50 cm

vasca singola

- Art. **F864** - p. 385
Per mobile da L 85 a 105 cm
- Art. **F865** - p. 385
Per mobile da L 106 a 140 cm
- Art. **F866** - p. 385
Per mobile da L 141 a 175 cm
- Art. **F867** - p. 385
Per mobile da L 176 a 190 cm
- Art. **F868** - p. 385
Per mobile da L 191 a 220 cm
- Art. **F869** - p. 385
Per mobile da L 221 a 250 cm



Rettangolare 64

Piani top sp. 1,2 cm (senza foro troppo pieno)
Th. 1,2 cm tops (without overflow)
Plan de toilette H 1,2 cm (sans trop-plein)

Corian / corian / corian
Vasca L 64 x P 32 x H 12 cm /
interior W 64 x D 32 x H 12 cm /
vasque int. L 64 x P 32 x H 12 cm

Per basi portalavabo min. L 70 x P 50 cm /
for washbasin units min. W 70 x D 50 cm /
meuble S/lavabo L 70 x P 50 cm

vasca singola
one sink / 1 vasque

vasca doppia
twin sink / double vasque

Art. F411 - p. 385
Per mobile da L 70 a 105 cm

Art. F517 - p. 385
Per mobile da L 140 a 175 cm

Art. F412 - p. 385
Per mobile da L 106 a 140 cm

Art. F518 - p. 385
Per mobile da L 176 a 190 cm

Art. F413 - p. 385
Per mobile da L 141 a 175 cm

Art. F519 - p. 385
Per mobile da L 191 a 220 cm

Art. F414 - p. 385
Per mobile da L 176 a 190 cm

Art. F520 - p. 385
Per mobile da L 221 a 250 cm

Art. F415 - p. 385
Per mobile da L 191 a 220 cm

Art. F416 - p. 385
Per mobile da L 221 a 250 cm

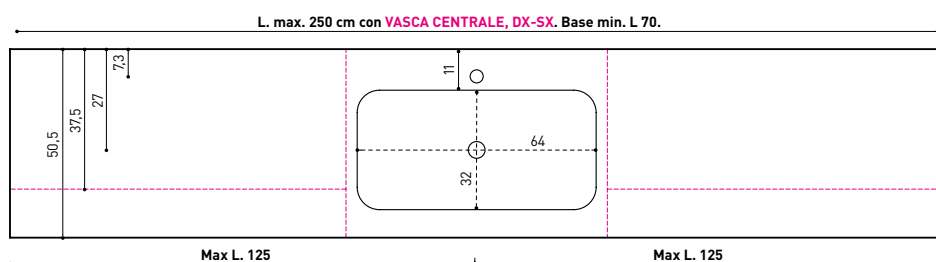

Occhio grande

Piani top sp. 1,2 cm (senza foro troppo pieno)
Th. 1,2 cm tops (without overflow)
Plan de toilette H 1,2 cm (sans trop-plein)

Corian / corian / corian
Vasca L 84 x P 32 x H 12 cm /
interior W 84 x D 32 x H 12 cm /
vasque int. L 84 x P 32 x H 12 cm

Per basi portalavabo min. L 95 x P 50 cm /
for washbasin units min. W 95 x D 50 cm /
meuble S/lavabo L 95 x P 50 cm

vasca singola
one sink / 1 vasque

Art. F421 - p. 385
Per mobile da L 95 a 105 cm

Art. F422 - p. 385
Per mobile da L 106 a 140 cm

Art. F423 - p. 385
Per mobile da L 141 a 175 cm

Art. F424 - p. 385
Per mobile da L 176 a 190 cm

Art. F425 - p. 385
Per mobile da L 191 a 220 cm

Art. F426 - p. 385
Per mobile da L 221 a 250 cm

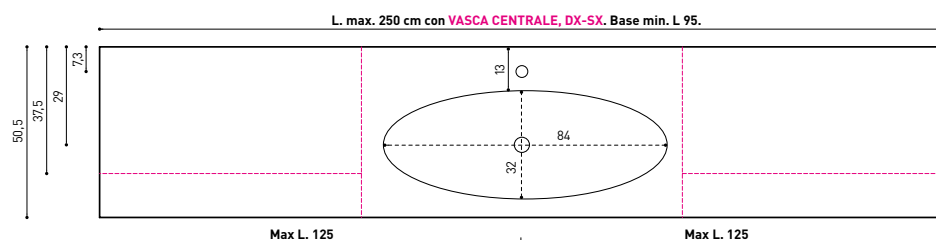



Ovale 65

Piani top sp. 1,2 cm (senza foro troppo pieno)
 Th. 1,2 cm tops (without overflow)
 Plan de toilette H 1,2 cm (sans trop-plein)

Corian / corian / corian
 Vasca L 65 x P 32 x H 12 cm /
 interior W 65 x D 32 x H 12 cm /
 vasque int. L 65 x P 32 x H 12 cm

Per basi portlavabo min. L 70 x P 50 cm /
 for washbasin units min. W 70 x D 50 cm /
 meuble S/lavabo L 70 x P 50 cm

Per basi portlavabo Fusion min. L 85 x P 50 cm /
 for Fusion washbasin units min. W 85 x D 50 cm /
 meuble S/lavabo Fusion L 85 x P 50 cm

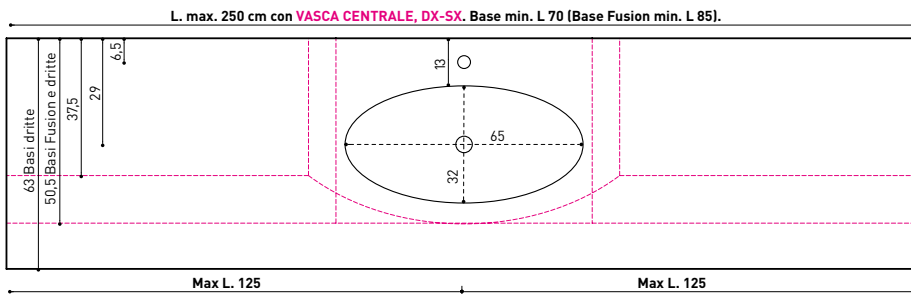

vasca singola
 one sink / 1 vasque

vasca doppia
 twin sink / double vasque

Art. **F401** - P. 385
 Per mobile da L 70 a 105 cm

Art. **F513** - P. 385
 Per mobile da L 140 a 175 cm

Art. **F402** - P. 385
 Per mobile da L 106 a 140 cm

Art. **F514** - P. 385
 Per mobile da L 176 a 190 cm

Art. **F403** - P. 385
 Per mobile da L 141 a 175 cm

Art. **F515** - P. 385
 Per mobile da L 191 a 220 cm

Art. **F404** - P. 385
 Per mobile da L 176 a 190 cm

Art. **F516** - P. 385
 Per mobile da L 221 a 250 cm

Art. **F405** - P. 385
 Per mobile da L 191 a 220 cm

Art. **F406** - P. 385
 Per mobile da L 221 a 250 cm



Dilva

Piani top sp. 1 cm (senza foro troppo pieno)
Th. 1 or 1,5 cm tops (without overflow)
Plan de toilette H 1 cm (sans trop-plein)

Cristallo / glass / verre
Vasca L 72 x P 35 x H 12 cm /
interior W 72 x D 35 x H 12 cm /
vasque int. L 72 x P 35 x H 12 cm

Per basi portalavabo min. L 85 x P 50 cm /
for washbasin units min. W 85 x D 50 cm /
meuble S/lavabo L 85 x P 50 cm



Sp. /Th. / Ép. 1 cm

Art. **F311** - p. 387
Per mobile da L 85 a 105 cm

Art. **F312** - p. 387
Per mobile da L 106 a 140 cm

Art. **F313** - p. 387
Per mobile da L 141 a 175 cm

Art. **F314** - p. 387
Per mobile da L 176 a 190 cm

Art. **F315** - p. 387
Per mobile da L 191 a 220 cm

Art. **F316** - p. 387
Per mobile da L 221 a 250 cm

Afro

Piani top sp. 1 cm (senza foro troppo pieno)
Th. 1 or 1,5 cm tops (without overflow)
Plan de toilette H 1 ou 1,5 cm (sans trop-plein)

Cristallo / glass / verre
Vasca L 73,5 x P 37,5 x H 14 cm /
interior W 73,5 x D 37,5 x H 14 cm /
vasque int. L 73,5 x P 37,5 x H 14 cm

Per basi portalavabo min. L 85 x P 50 cm /
for washbasin units min. W 85 x D 50 cm /
meuble S/lavabo L 85 x P 50 cm



Sp. /Th. / Ép. 1 cm

Art. **F356** - p. 387
Per mobile da L 85 a 105 cm

Art. **F357** - p. 387
Per mobile da L 106 a 140 cm

Art. **F358** - p. 387
Per mobile da L 141 a 175 cm

Art. **F359** - p. 387
Per mobile da L 176 a 190 cm

Art. **F360** - p. 387
Per mobile da L 191 a 220 cm

Art. **F371** - p. 387
Per mobile da L 221 a 250 cm



Dilva

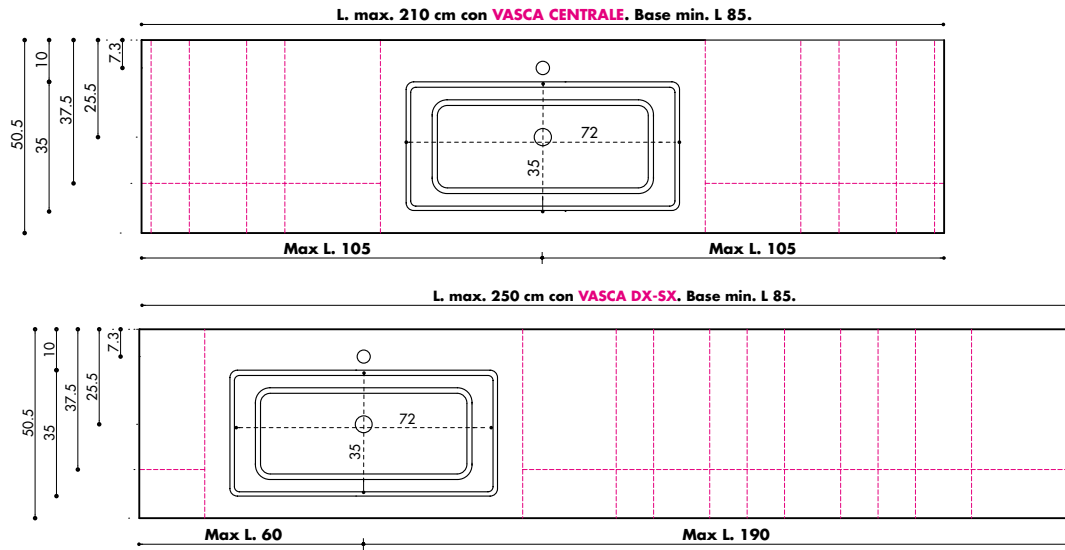

Afro

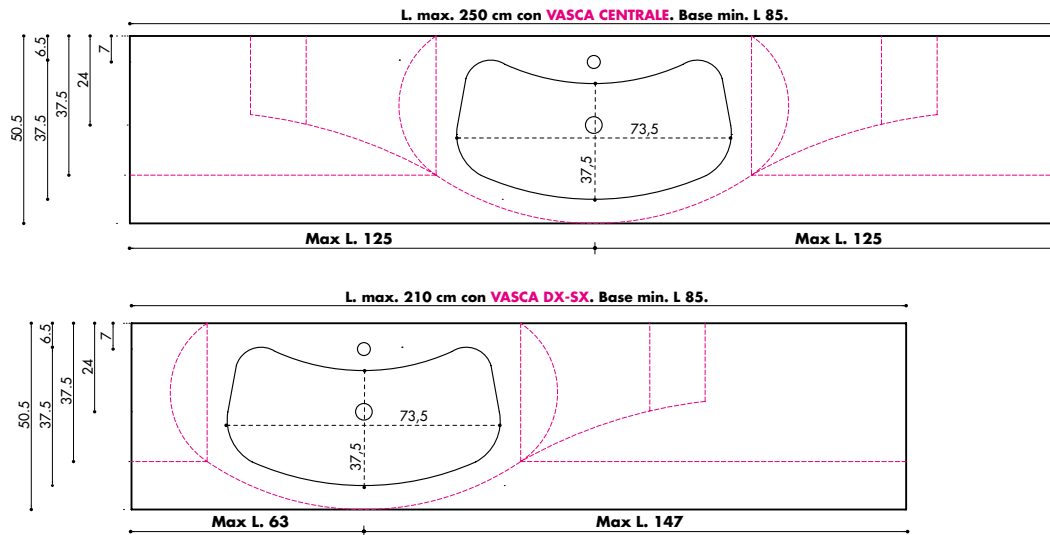

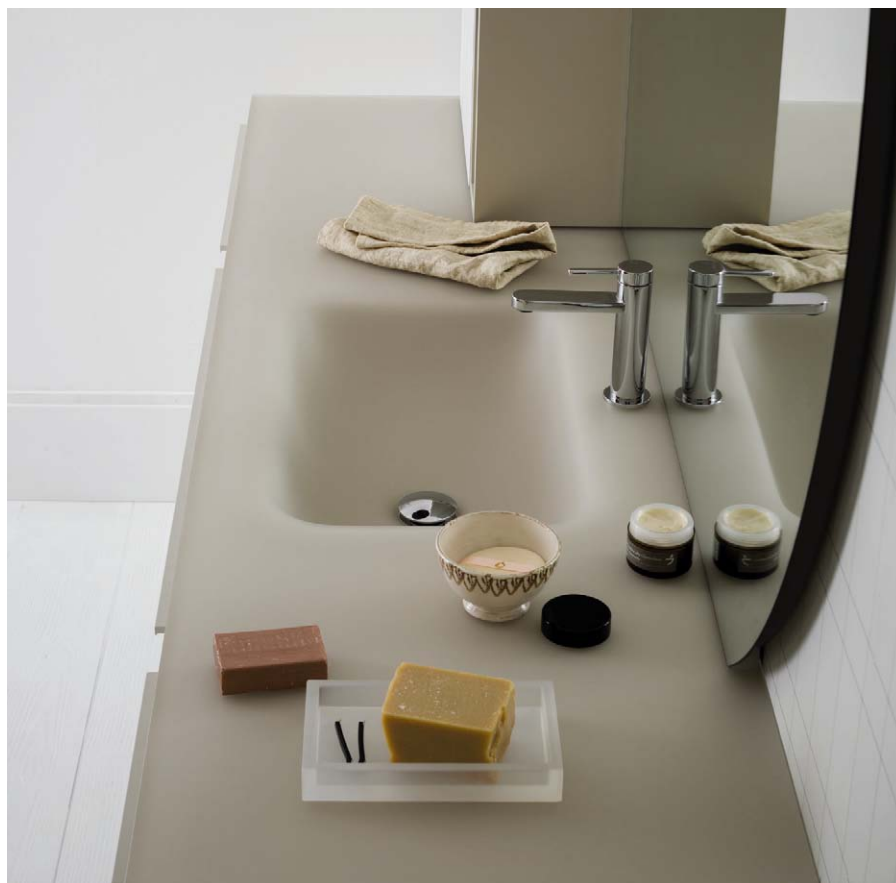

Rettangolare piccolo

Piani top sp. 1 cm (senza foro troppo pieno)
Th. 1 cm tops (without overflow)
Plan de toilette H 1 cm (sans trop-plein)

Cristallo / glass / verre

Vasca L 51 x P 31 x H 13 cm /
interior W 51 x D 31 x H 13 cm /
vasque int. L 51 x P 31 x H 13 cm

Per basi portalavabo min. L 70 x P 50 cm /
for washbasin units min. W 70 x D 50 cm /
meuble S/lavabo L 70 x P 50 cm



Sp. /Th. / Ép. **1 cm**

vasca singola

one sink / 1 vasque

Art. **F493** - P. 387
Per mobile da L 70 a 105 cm

Art. **F494** - P. 387
Per mobile da L 106 a 140 cm

Art. **F495** - P. 387
Per mobile da L 141 a 175 cm

Art. **F496** - P. 387
Per mobile da L 176 a 190 cm

Art. **F497** - P. 387
Per mobile da L 191 a 220 cm

Art. **F498** - P. 387
Per mobile da L 221 a 250 cm

vasca doppia

twin sink / double vasque

Art. **F278** - P. 387
Per mobile da L 140 a 175 cm

Art. **F279** - P. 387
Per mobile da L 176 a 190 cm

Art. **F280** - P. 387
Per mobile da L 191 a 220 cm

Art. **F281** - P. 387
Per mobile da L 221 a 250 cm



Ovale 57

Piani top sp. 1 cm (senza foro troppo pieno)
Th. 1 cm tops (without overflow)
Plan de toilette H 1 cm (sans trop-plein)

Cristallo / glass / verre

Vasca L 57 x P 31 x H 13 cm /
interior W 57 x D 31 x H 13 cm /
vasque int. L 57 x P 31 x H 13 cm

Per basi portalavabo min. L 70 x P 50 cm /
for washbasin units min. W 70 x D 50 cm /
meuble S/lavabo L 70 x P 50 cm



Sp. /Th. / Ép. **1 cm**

Art. **F431** - P. 387
Per mobile da L 70 a 105 cm

Art. **F432** - P. 387
Per mobile da L 106 a 140 cm

Art. **F433** - P. 387
Per mobile da L 141 a 170 cm

Art. **F434** - P. 387
Per mobile da L 171 a 190 cm

Art. **F435** - P. 387
Per mobile da L 191 a 220 cm

Art. **F436** - P. 387
Per mobile da L 221 a 250 cm

Rettangolare piccolo

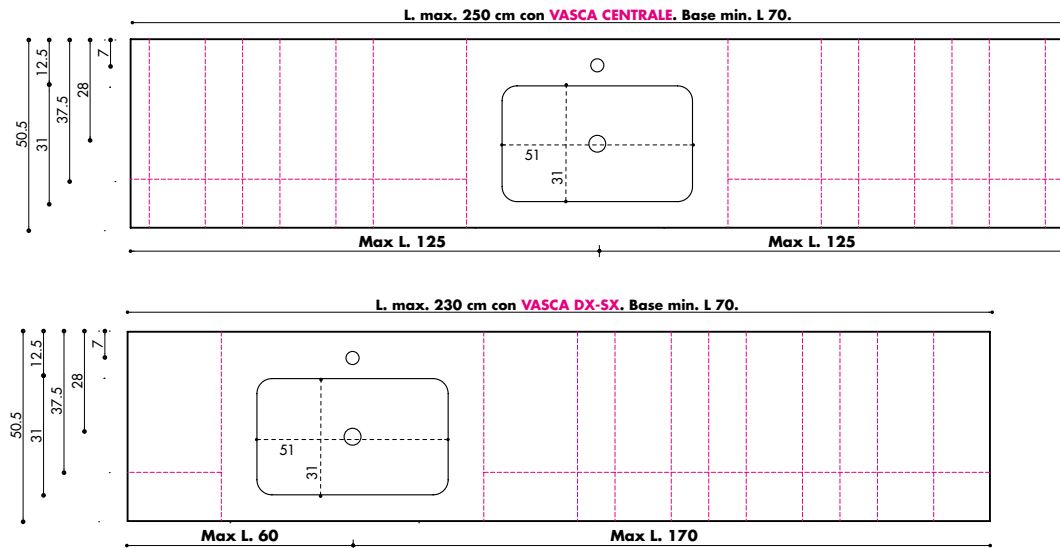

Ovale 57

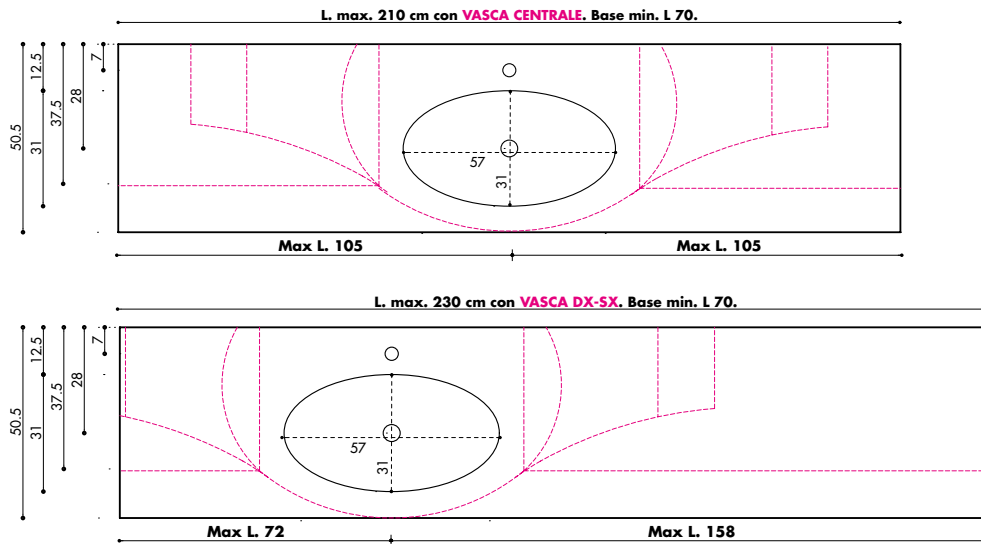



Finiture / finishes / finitions **ZEN, KARMA, TANTRA, YOGA e MANTRA**

quarzo resina Rocface:

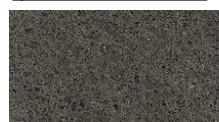

2C Taupe

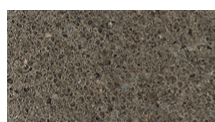

2D Fango

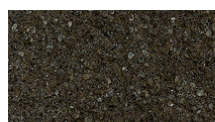

2E Torba

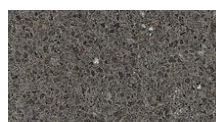

2F Grigio sasso

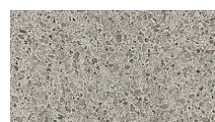

2G Greige

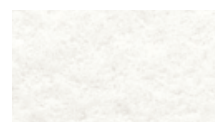

2H Superwhite

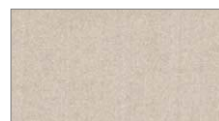

GRES
AJ Iris Ivory



GRES
AK Iris Plumb



GRES
AL Iris Silver

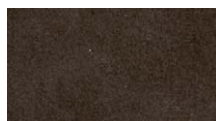

GRES
AM Iris Amber

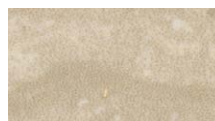

GRES
AQ Florim Travertino

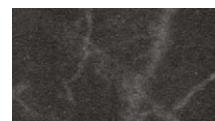

LAMINAM
AI Nero Greco opaco



GRES
AS Florim Amani opaco

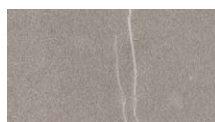

GRES
AR Florim Amani lucido



LAMINAM
AV Pietra Grey opaco



GRES
AP Iris Gaudi Stone lucido



GRES
AN Iris Calacatta opaco



GRES
AO Iris Bianco Venato op.

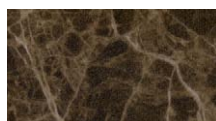

LAMINAM
AW Emperador extra luc.



LAMINAM
AX Statuarietto opaco



LAMINAM
DO Bianco Assoluto opaco



LAMINAM
AY Noir Desir lucido

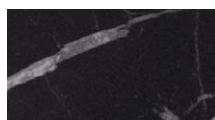

GRES
AZ Iris Black Marquinia



CORIAN
(solo per lavabi **KARMA** e
ZEN IN APPOGGIO)





Zen - free standing

Lavabo ZEN / floor-standing washbasin / lavabo à poser au sol

> A terra con foro per rubinetto /
with hole for mixer /
au sol avec trou pour robinet

Art. **A641** - P. 357

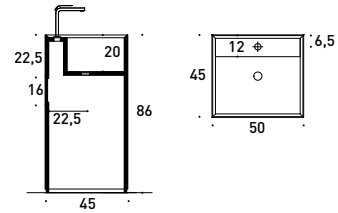

> Per rubinetto a terra /
for floor-standing mixer /
pour robinet au sol

Art. **A642** - P. 357

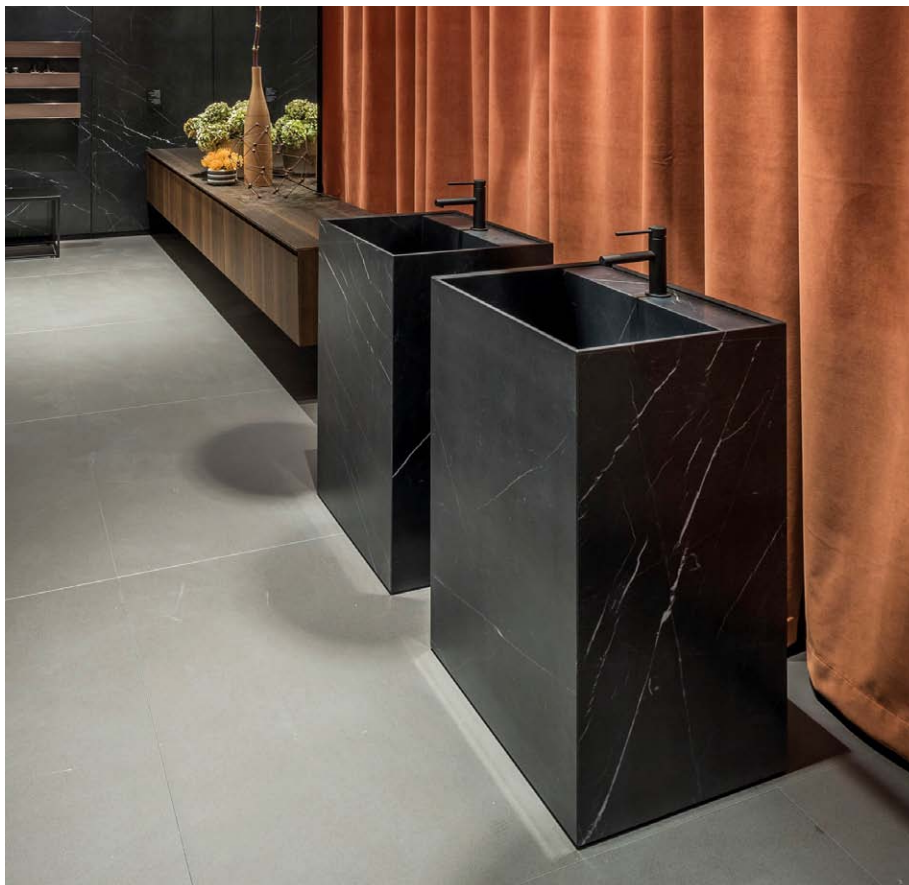
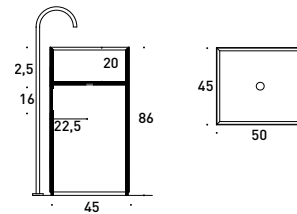

Zen - appoggio a muro

Lavabo ZEN / floor-standing washbasin to the wall / lavabo à poser au sol appuyé au mur

> Con foro per rubinetto /
with hole for mixer /
avec trou pour robinet

Art. **A834** - P. 357

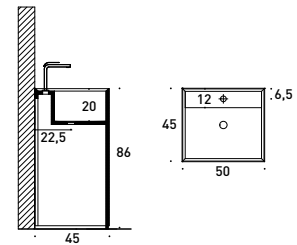

> Per rubinetto a parete /
with mixer on the wall /
pour robinet au mur

Art. **A835** - P. 357

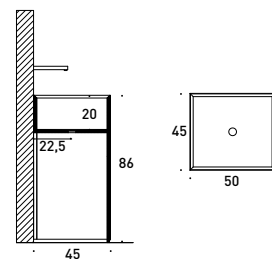



Zen in appoggio

Lavabo ZEN **senza foro per rubinetto** /
wall-hung ZEN washbasin **without tap hole cutout** /
lavabo ZEN à poser **sans trou pour robinet**

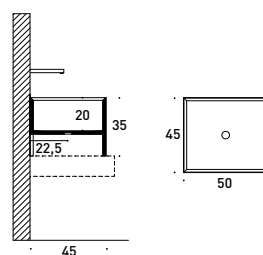

Art. **A644** - P. 357



Zen in appoggio

Lavabo ZEN **con foro per rubinetto** /
wall-hung ZEN washbasin **with tap hole cutout** /
lavabo ZEN à poser **avec trou pour robinet**

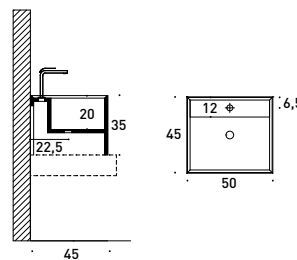

Art. **A643** - P. 357



Zen in appoggio CORIAN

Lavabo ZEN senza foro per rubinetto /
 wall-hung ZEN washbasin without tap hole cutout /
 lavabo ZEN à poser sans trou pour robinet

Finiture / finishes / finitions:

corian:
 DuPont™
CORIAN®
 SOLID SURFACES

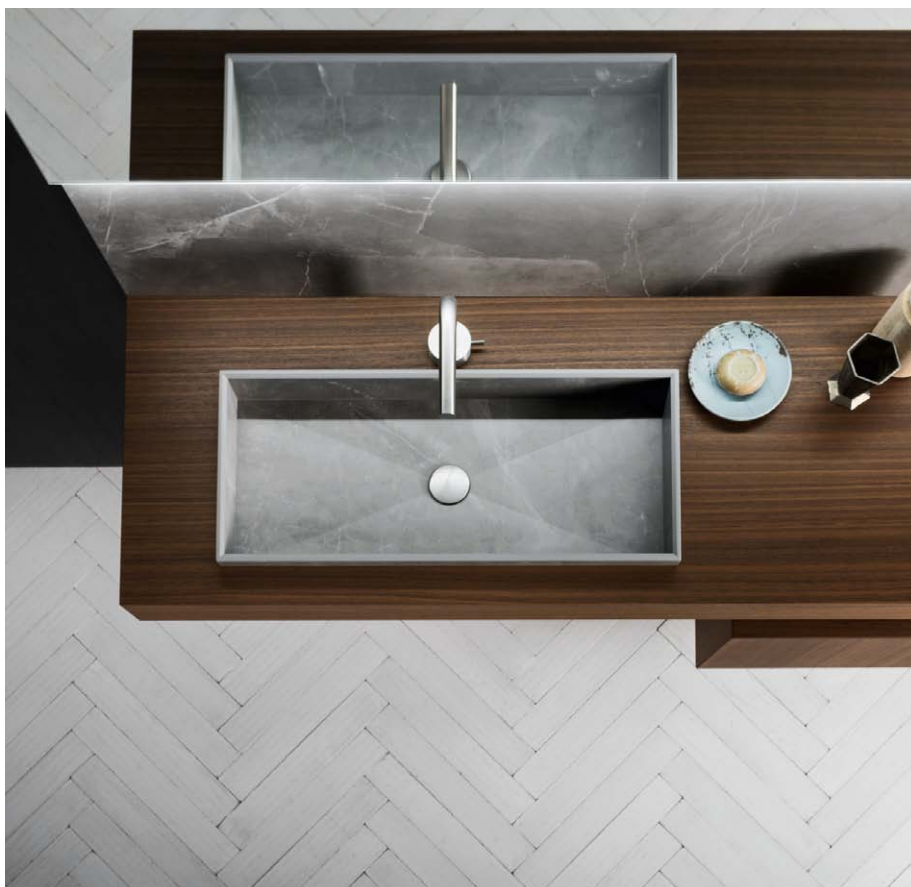
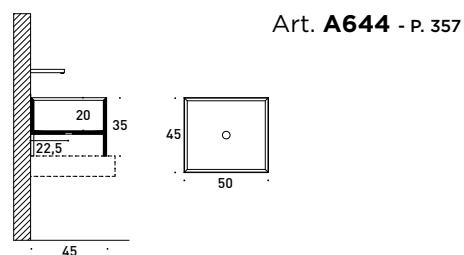

Yoga 50 e 70

Lavabo YOGA senza foro per rubinetto /
 wall-hung YOGA washbasin without tap hole /
 lavabo YOGA à poser sans trou pour robinet

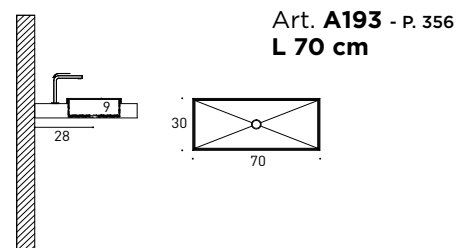
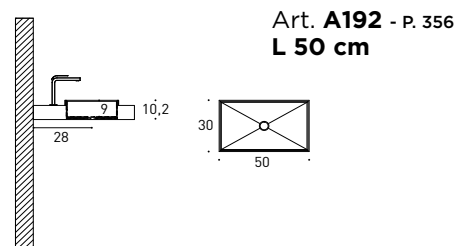





Karma in appoggio

Lavabo KARMA con foro per rubinetto /
 wall-hung KARMA washbasin with tap hole /
 lavabo KARMA à poser avec trou pour robinet

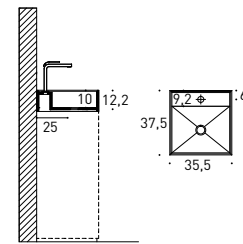

Art. **A195** - P. 356

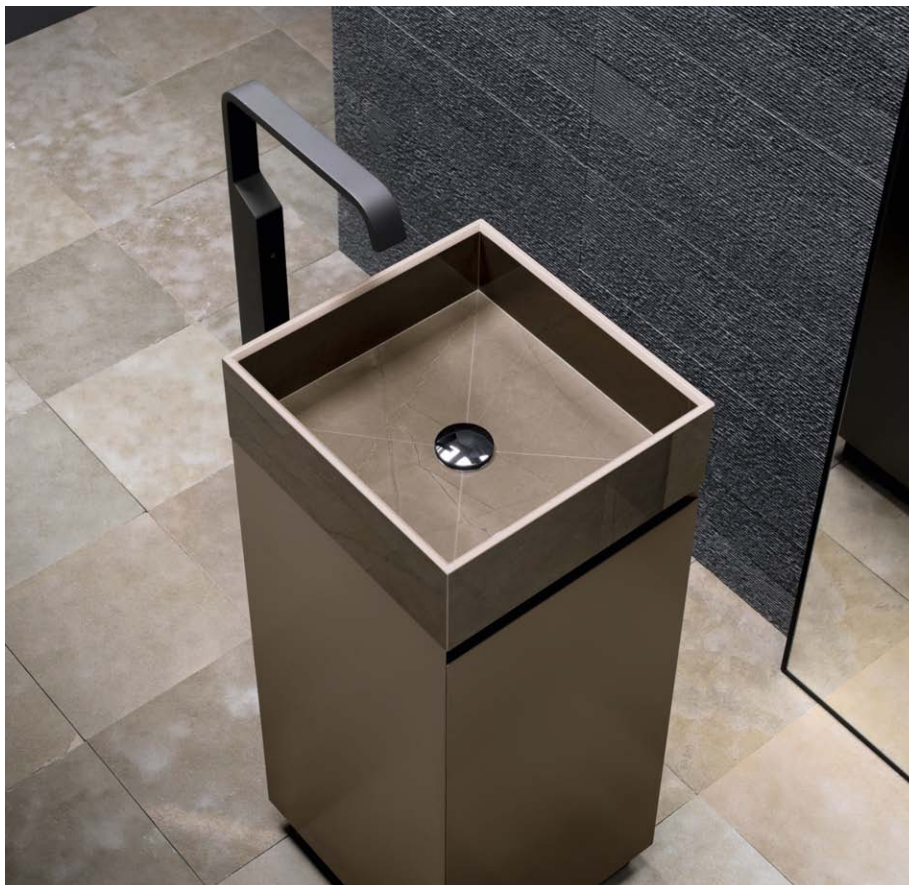

Karma in appoggio

Lavabo KARMA senza foro per rubinetto /
 wall-hung MANTRA washbasin without tap hole /
 lavabo MANTRA à poser sans trou pour robinet

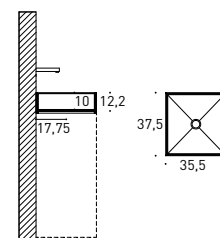

Art. **A194** - P. 356



Mantra H 12,2 cm

Lavabo MANTRA H 12,2 cm con foro per rubinetto /
wall-hung MANTRA H 12,2 cm washbasin with tap hole /
lavabo MANTRA H 12,2 cm à poser avec trou pour robinet

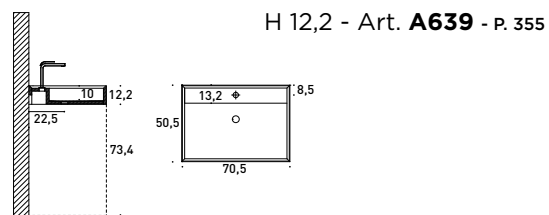

Mantra H 24,4 cm

Lavabo MANTRA H 24,4 cm con foro per rubinetto /
wall-hung MANTRA H 24,4 cm washbasin with tap hole /
lavabo MANTRA H 24,4 cm à poser avec trou pour robinet

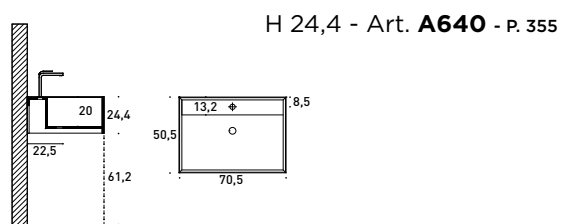







Tantra con foro

Lavabo TANTRA dx-sx con foro per rubinetto /
 wall-hung TANTRA rh-li washbasin with tap hole /
 lavabo TANTRA dr-ga à poser avec trou pour robinet

Art. **A097** - P. 356

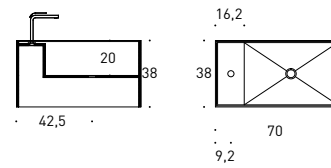

Tantra senza foro

Lavabo TANTRA dx-sx senza foro per rubinetto /
 wall-hung TANTRA rh-li washbasin without tap hole /
 lavabo TANTRA dr-ga à poser sans trou pour robinet

Art. **A096** - P. 356

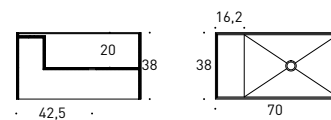



BATHTUBS
BAIGNOIRES

VASCHE
DA BAGNO





MENEGHELLO PAOLELLI
ASSOCIATI

Panier

Vasca da bagno Panier con piletta bianca e kit sifone. Disponibile in mineralguss e tekno.

Senza troppo pieno /

Panier bathtub with white plug and drain kit. Available in mineralguss and tekno.

Without overflow hole /

Baignoire Panier avec bonde blanc et kit siphon. En mineralguss et tekno. Sans trop-plein.

Art. **A464** - P. 406

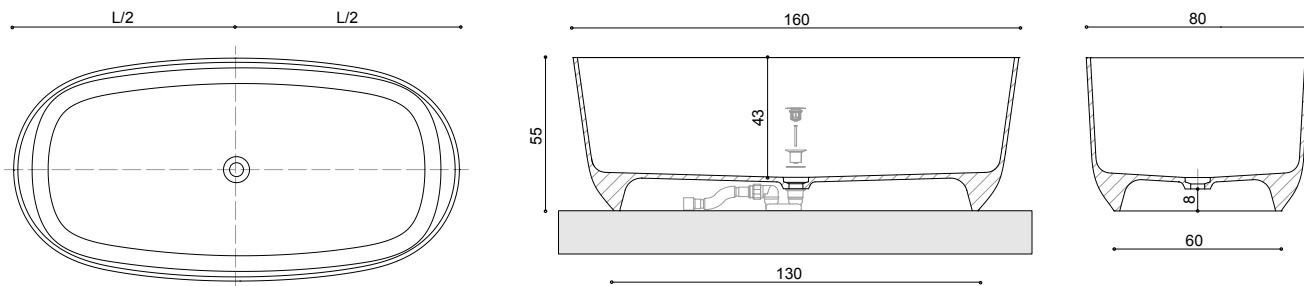

⚠ ATTENZIONE! / ATTENTION!
Rubinetto a muro o colonna a terra.
Mixer on the wall or floor-standing
mixer. Robinet au mur ou colonne
au sol.







MENEGHELLO PAOLELLI
ASSOCIATI

Belt

Vasca da bagno Belt con piletta cromata Stop and Go e kit sifone. Senza troppo pieno. Disponibile in tekno. /
Belt bathtub with chrome Stop & Go plug and drain kit. Without integrated overflow hole. Available in tekno. /
Baignoire Belt avec bonde chromée Stop & Go et kit siphon (sans trop-plein intégré). En tekno.

Art. **A274** - P. 406

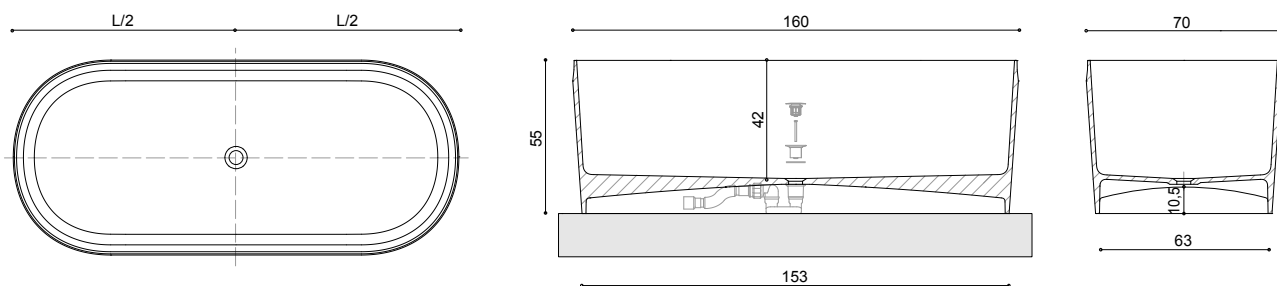

⚠ ATTENZIONE! / ATTENTION!
Rubinetto a muro o colonna a terra.
Mixer on the wall or floor-standing mixer. Robinet au mur ou colonne au sol.





Clio

Vasca da bagno Clio con piletta cromata Stop and Go e kit sifone. Con troppo pieno integrato.
Disponibile in mineralguss e in tekno. /
Clio bathtub with chrome Stop & Go plug and drain kit. With integrated overflow hole.
Available in mineralguss and tekno. /
Baignoire Clio avec bonde chromée Stop & Go et kit siphon (avec trop-plein intégré).
En mineralguss ou tekno.

Art. **A433** - P. 407

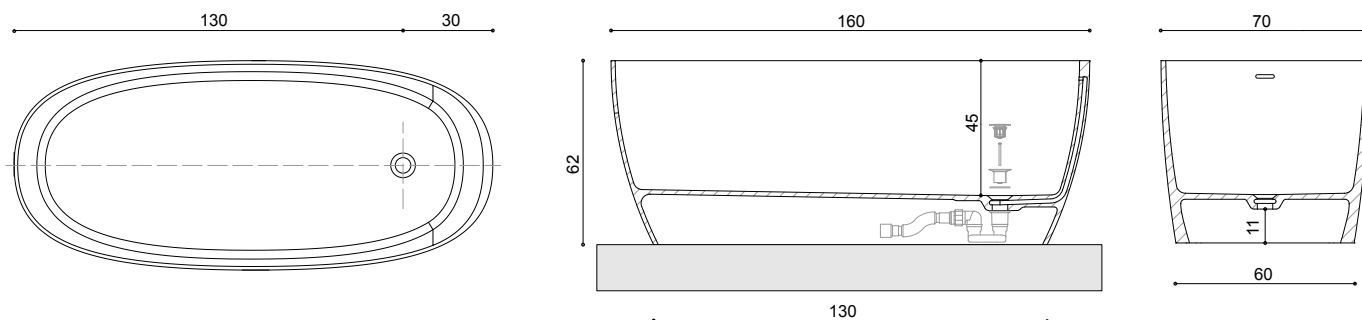

⚠ ATTENZIONE! / ATTENTION!
Rubinetto a muro o colonna a terra.
Mixer on the wall or floor-standing
mixer. Robinet au mur ou colonne
au sol.





Giulia

Vasca da bagno Giulia con piletta cromata Stop and Go e kit sifone. Senza troppo pieno.
Disponibile in mineralguss e in tekno. /
Giulia bathtub with Stop & Go chrome plug and drain kit. Without overflow hole.
Available in mineralguss and tekno. /
Baignoire Giulia avec bonde chromée Stop & Go et kit siphon (sans trop-plein).
En mineralguss ou tekno.

Art. **A457** - P. 407

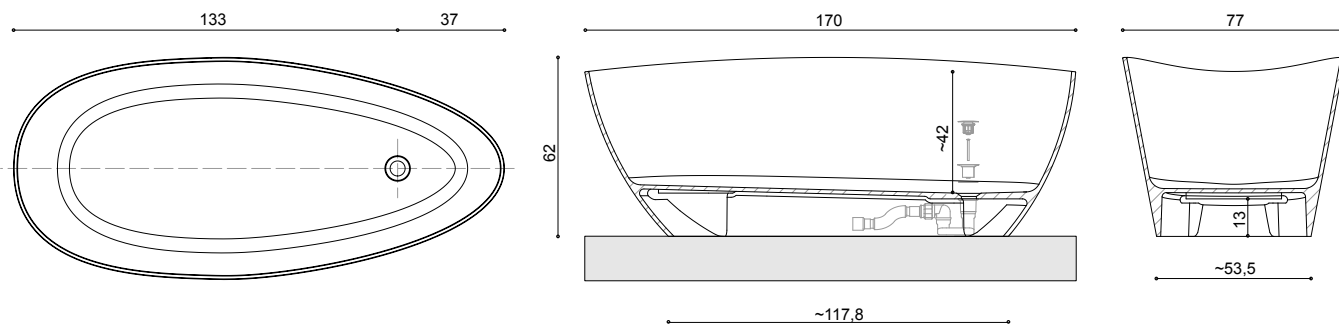

⚠ ATTENZIONE! / ATTENTION!
Rubinetto a muro o colonna a terra.
Mixer on the wall or floor-standing
mixer. Robinet au mur ou colonne
au sol.





Tub

Vasca da bagno Tub con piletta cromata Stop and Go e kit sifone. Senza troppo pieno.
Disponibile in mineralguss. /
Tub bathtub with Stop & Go chrome plug and drain kit. Without overflow hole.
Available in mineralguss. /
Baignoire Tub avec bonde chromée Stop & Go et kit siphon (sans trop-plein).
En mineralguss.

Art. **A458** - P. 408

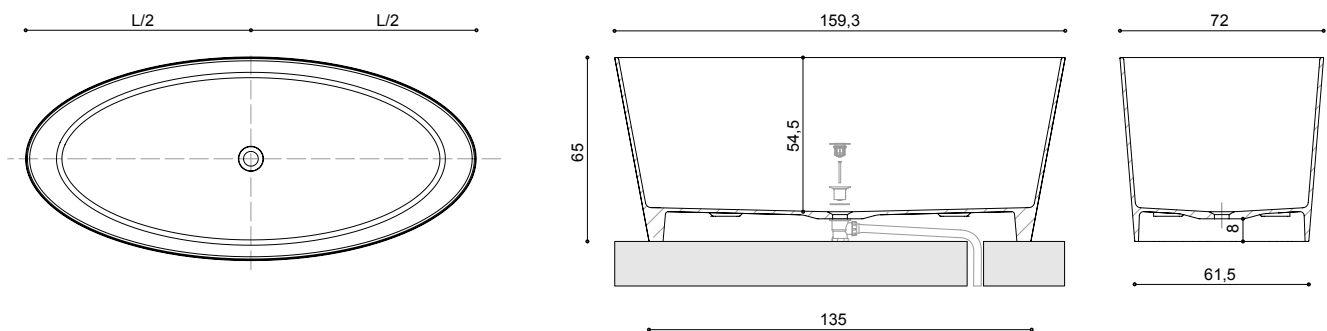

⚠ ATTENZIONE! / ATTENTION!
Rubinetto a muro o colonna a terra.
Mixer on the wall or floor-standing
mixer. Robinet au mur ou colonne
au sol.





Tania

Vasca da bagno Tania con piletta cromata Stop and Go e kit sifone. Con troppo pieno integrato.
Disponibile in mineralguss /
Tania bathtub with chrome Stop & Go plug and drain kit. With integrated overflow hole.
Available in mineralguss /
Baignoire Tania avec bonde chromée Stop & Go et kit siphon (avec trop-plein intégré).
En mineralguss.

Art. **A460** - P. 408

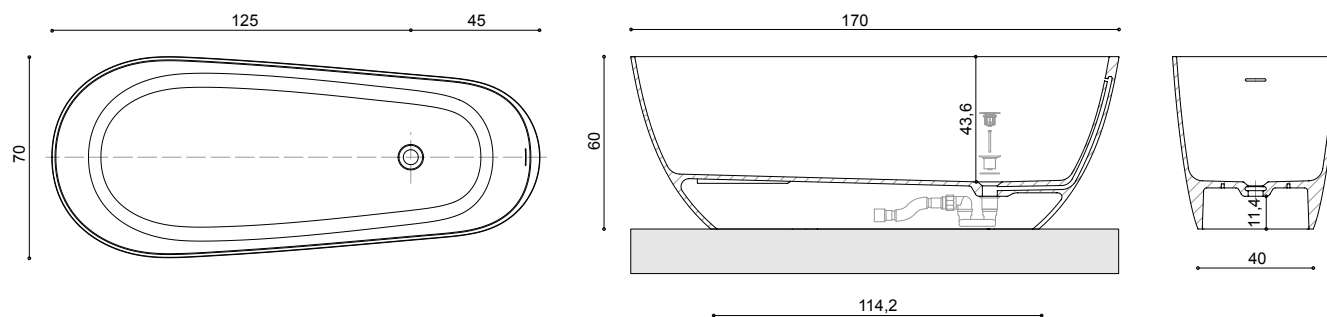

⚠ ATTENZIONE! / ATTENTION!
Rubinetto a muro o colonna a terra.
Mixer on the wall or floor-standing
mixer. Robinet au mur ou colonne
au sol.





Kuvet - scarico laterale

Vasca da bagno Kuvet con piletta bianca Stop and Go e kit sifone. Con troppo pieno integrato.
Disponibile in mineralguss e in tekno. /
Kuvet bathtub with Stop & Go white plug and drain kit. With integrated overflow hole.
Available in mineralguss and tekno. /
Baignoire Kuvet avec bonde blanc Stop & Go et kit siphon (avec trop-plein intégré).
En mineralguss ou tekno.

Art. **A462** - P. 409

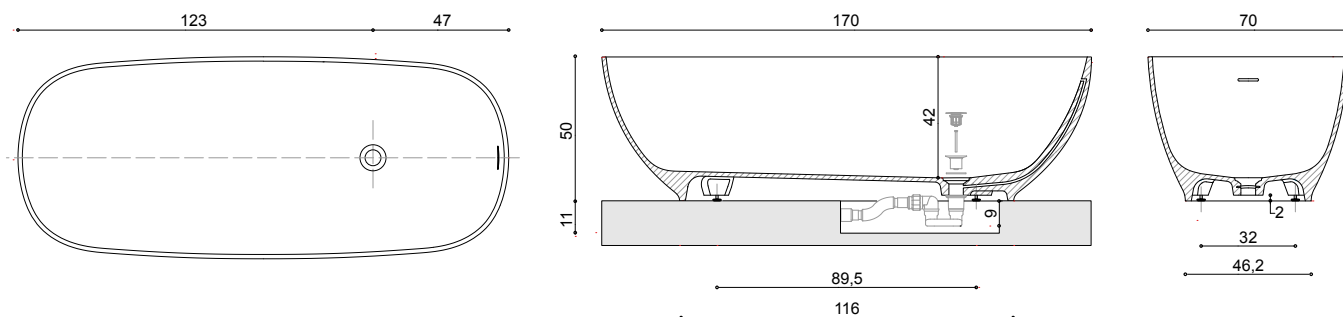

⚠ ATTENZIONE! / ATTENTION!
Rubinetto a muro o colonna a terra.
Mixer on the wall or floor-standing
mixer. Robinet au mur ou colonne
au sol.





MIRRORS

MIROIRS

SPECCHIERE

**FM!**

È possibile realizzare specchiere Light fuori misura (vedi listino) /
it is possible to realize Light mirrors oversize (see pricelist) /
il est possible de réaliser des miroirs Light sur mesure (voir tarif)

Light

Specchiera LIGHT con profilo in alluminio /
Mirror LIGHT with aluminium frame /
miroir LIGHT avec profil en aluminium.

Spessore 2,7 cm / Thick 2,7 cm / Épaisseur 2,7 cm

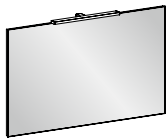

Con faretto MIKY 50 (V916) di serie /
with standard spotlight MIKY 50 (V916) /
avec spot MIKY 50 (V916) de série

110

Art. **S937** - P. 310
L 60 x H 49 cm

Art. **S260** - P. 310
L 60 x H 61,2 cm

Art. **S938** - P. 310
L 60 x H 73,4 cm

Art. **S949** - P. 310
L 105 x H 49 cm

Art. **S264** - P. 310
L 105 x H 61,2 cm

Art. **S950** - P. 310
L 105 x H 73,4 cm

Art. **S940** - P. 310
L 70 x H 49 cm

Art. **S261** - P. 310
L 70 x H 61,2 cm

Art. **S941** - P. 310
L 70 x H 73,4 cm

Art. **S952** - P. 310
L 120 x H 49 cm

Art. **S265** - P. 310
L 120 x H 61,2 cm

Art. **S953** - P. 310
L 120 x H 73,4 cm

Art. **S943** - P. 310
L 85 x H 49 cm

Art. **S262** - P. 310
L 85 x H 61,2 cm

Art. **S944** - P. 310
L 85 x H 73,4 cm

Art. **S955** - P. 310
L 130 x H 49 cm

Art. **S266** - P. 310
L 130 x H 61,2 cm

Art. **S956** - P. 310
L 130 x H 73,4 cm

Art. **S946** - P. 310
L 95 x H 49 cm

Art. **S263** - P. 310
L 95 x H 61,2 cm

Art. **S947** - P. 310
L 95 x H 73,4 cm

Art. **S958** - P. 310
L 140 x H 49 cm

Art. **S267** - P. 310
L 140 x H 61,2 cm

Art. **S959** - P. 310
L 140 x H 73,4 cm

FINITURA

Brill
(di serie)

FINITURE FM

Nero
ossidato

Bronzo
opaco



Con faretto THUNDER (V832) di serie /
with standard spotlight THUNDER (V832) /
avec spot THUNDER (V832) de série

Art. **S960** - P. 310
L 36,8 x H 95 cm

Art. **S961** - P. 310
L 49 x H 95 cm

Art. **S962** - P. 310
L 55,4 x H 95 cm

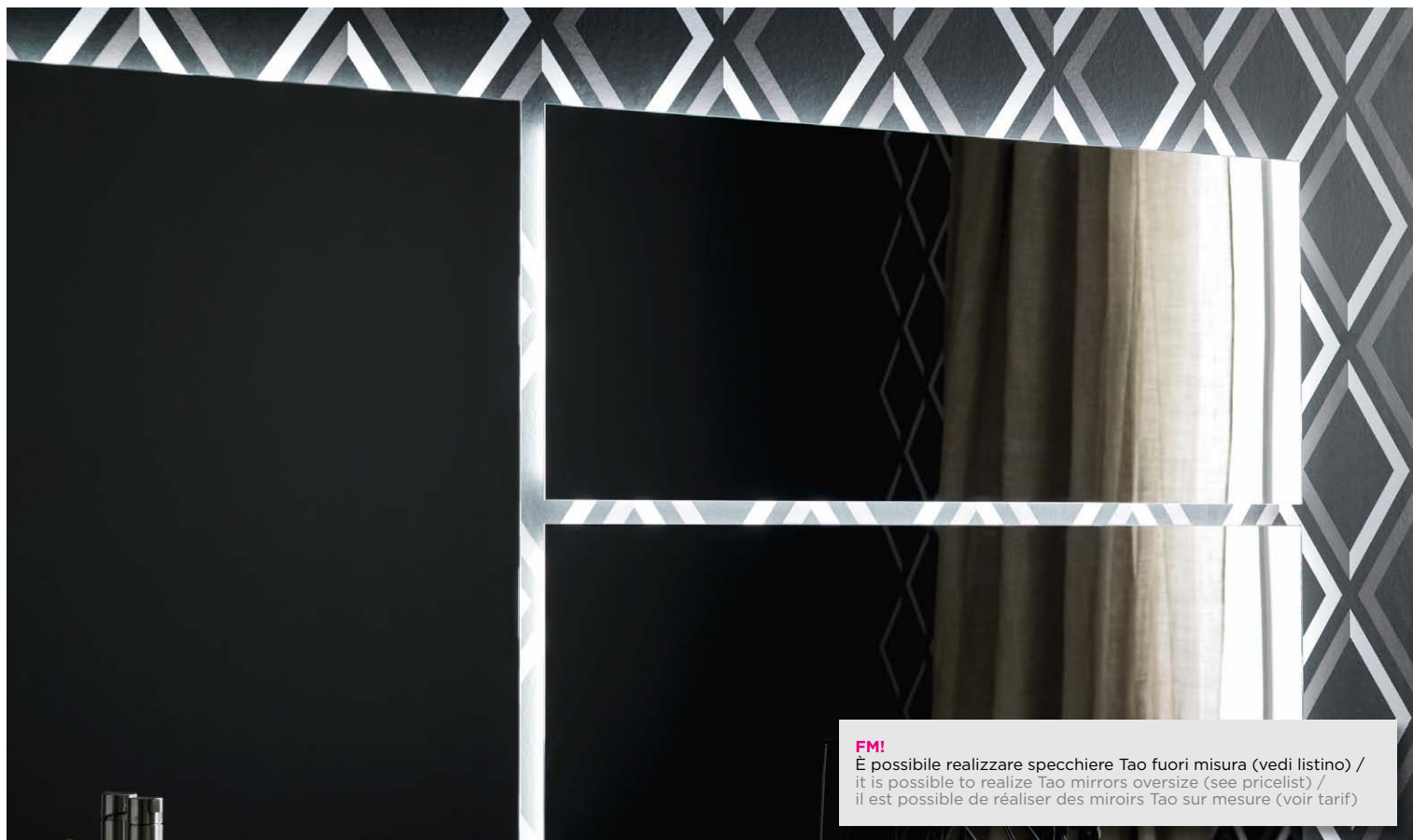

**FM!**

È possibile realizzare specchiere Tao fuori misura (vedi listino) /
it is possible to realize Tao mirrors oversize (see pricelist) /
il est possible de réaliser des miroirs Tao sur mesure (voir tarif)

Tao

Specchiera TAO con profilo in alluminio e luce led perimetrale /
Mirror TAO with aluminium frame and perimeter led /
miroir TAO avec profil en aluminium et led isopérimétré.

Spessore 3,5 cm / Thick 3,5 cm / Épaisseur 3,5 cm

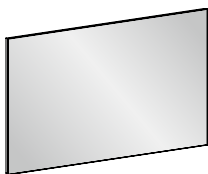

È possibile aggiungere faretto alla specchiera /
Spotlight available for this mirror /
Il est possible d'ajouter des spots au miroir

Art. **S751** - P. 311
L 60 x H 61,2 cm

Art. **S753** - P. 311
L 70 x H 61,2 cm

Art. **S755** - P. 311
L 85 x H 61,2 cm

Art. **S757** - P. 311
L 95 x H 61,2 cm

Art. **S752** - P. 311
L 60 x H 73,4 cm

Art. **S754** - P. 311
L 70 x H 73,4 cm

Art. **S756** - P. 311
L 85 x H 73,4 cm

Art. **S758** - P. 311
L 95 x H 73,4 cm

Art. **S759** - P. 311
L 105 x H 61,2 cm

Art. **S761** - P. 311
L 120 x H 61,2 cm

Art. **S763** - P. 311
L 130 x H 61,2 cm

Art. **S765** - P. 311
L 140 x H 61,2 cm

Art. **S760** - P. 311
L 105 x H 73,4 cm

Art. **S762** - P. 311
L 120 x H 73,4 cm

Art. **S764** - P. 311
L 130 x H 73,4 cm

Art. **S766** - P. 311
L 140 x H 73,4 cm



**FM!**

È possibile realizzare specchiere Boheme fuori misura (vedi listino) /
it is possible to realize Boheme mirrors oversize (see pricelist) /
il est possible de réaliser des miroirs Boheme sur mesure (voir tarif)

Boheme

Specchiera BOHEME con profilo in alluminio /
Mirror BOHEME with aluminium frame/
miroir BOHEME avec profil en aluminium.

Spessore 3,9 cm / Thick 3,9 cm / Épaisseur 3,9 cm

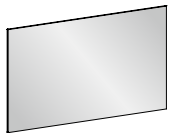
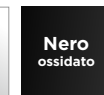
**FINITURE****FINITURE FM**

114

Non è possibile aggiungere faretto alla specchiera /
No spotlight available for this mirror /
Il est impossible d'ajouter des spots au miroir

Art. **S973** - P. 312
L 60 x H 61,2 cm

Art. **S974** - P. 312
L 70 x H 61,2 cm

Art. **S975** - P. 312
L 85 x H 61,2 cm

Art. **S976** - P. 312
L 95 x H 61,2 cm

Art. **S981** - P. 312
L 60 x H 73,4 cm

Art. **S982** - P. 312
L 70 x H 73,4 cm

Art. **S983** - P. 312
L 85 x H 73,4 cm

Art. **S984** - P. 312
L 95 x H 73,4 cm

Art. **S977** - P. 312
L 105 x H 61,2 cm

Art. **S978** - P. 312
L 120 x H 61,2 cm

Art. **S979** - P. 312
L 130 x H 61,2 cm

Art. **S980** - P. 312
L 140 x H 61,2 cm

Art. **S985** - P. 312
L 105 x H 73,4 cm

Art. **S986** - P. 312
L 120 x H 73,4 cm

Art. **S987** - P. 312
L 130 x H 73,4 cm

Art. **S988** - P. 312
L 140 x H 73,4 cm

Alla specchiera Boheme è possibile aggiungere la
mensola Boheme L 35, 50 o 70 cm /

The **Boheme shelf** can be added to the Boheme mirror in the following sizes: W 35, 50 or 70 cm /

Au miroir Boheme il est possible d'ajouter l'**étagère Boheme** L 35, 50 ou 70 cm.

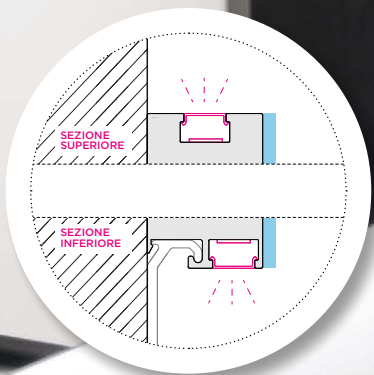

**FM!**

È possibile realizzare specchiere Hide fuori misura (vedi listino) /
it is possible to realize Hide mirrors oversize (see pricelist) /
il est possible de réaliser des miroirs Hide sur mesure (voir tarif)

Hide

Specchiera HIDE con profilo in alluminio /
Mirror HIDE with aluminium frame/
miroir HIDE avec profil en aluminium.

Spessore 5,3 cm / Thick 5,3 cm / Épaisseur 5,3 cm

FINITURE

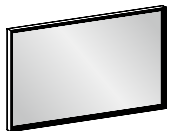
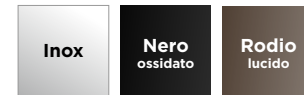

116

Non è possibile aggiungere faretti alla specchiera /
No spotlight available for this mirror /
Il est impossible d'ajouter des spots au miroir

Luce perimetrale posteriore a richiesta /
Rear perimeter light on request /
Éclairage périmétral derrière sur demande

Art. **S888** - P. 313
L 60 x H 61,2 cm

Art. **S889** - P. 313
L 70 x H 61,2 cm

Art. **S890** - P. 313
L 85 x H 61,2 cm

Art. **S891** - P. 313
L 95 x H 61,2 cm

Art. **S592** - P. 313
L 60 x H 73,4 cm

Art. **S593** - P. 313
L 70 x H 73,4 cm

Art. **S594** - P. 313
L 85 x H 73,4 cm

Art. **S595** - P. 313
L 95 x H 73,4 cm

Art. **S892** - P. 313
L 105 x H 61,2 cm

Art. **S893** - P. 313
L 120 x H 61,2 cm

Art. **S894** - P. 313
L 130 x H 61,2 cm

Art. **S895** - P. 313
L 140 x H 61,2 cm

Art. **S596** - P. 313
L 105 x H 73,4 cm

Art. **S597** - P. 313
L 120 x H 73,4 cm

Art. **S598** - P. 313
L 130 x H 73,4 cm

Art. **S599** - P. 313
L 140 x H 73,4 cm

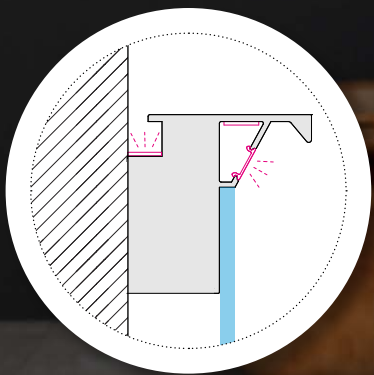
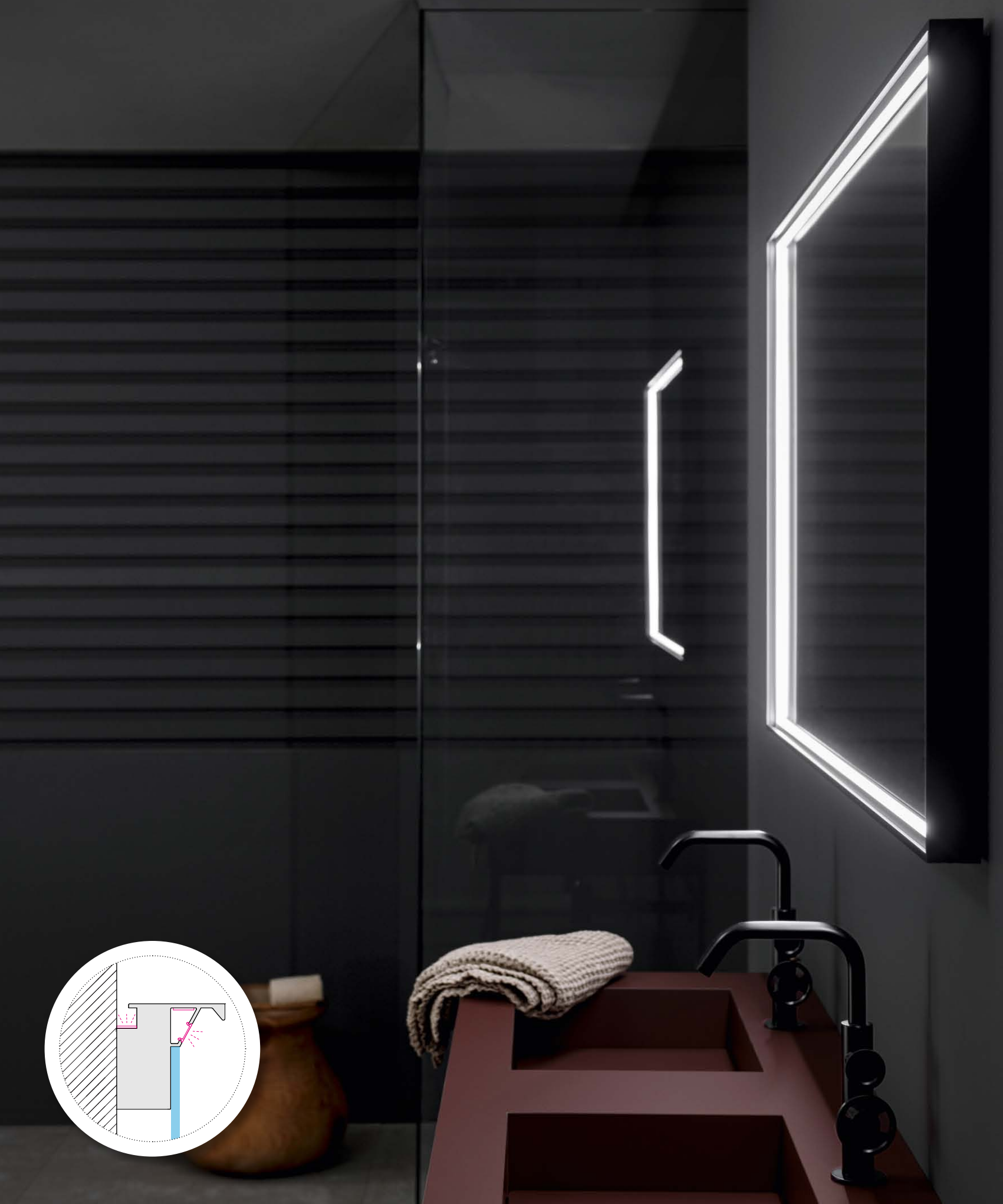

**FM!**

È possibile realizzare specchiere Naike fuori misura (vedi listino) /
it is possible to realize Naike mirrors oversize (see pricelist) /
il est possible de réaliser des miroirs Naike sur mesure (voir tarif)

Naike

Specchiera NAIKE con profilo in alluminio /
Mirror NAIKE with aluminium frame /
miroir NAIKE avec profil en aluminium.

Spessore 7,2 cm / Thick 7,2 cm / Épaisseur 7,2 cm

FINITURE

Bianco
opaco

Nero
ossidato

Inox

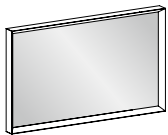

Non è possibile aggiungere faretti alla specchiera /
No spotlight available for this mirror /
Il est impossible d'ajouter des spots au miroir

Luce perimetrale posteriore a richiesta /
Rear perimeter light on request /
Éclairage périmétral derrière sur demande

Art. **S872** - P. 314
L 60 x H 61,2 cm

Art. **S873** - P. 314
L 70 x H 61,2 cm

Art. **S874** - P. 314
L 85 x H 61,2 cm

Art. **S875** - P. 314
L 95 x H 61,2 cm

Art. **S880** - P. 314
L 60 x H 73,4 cm

Art. **S881** - P. 314
L 70 x H 73,4 cm

Art. **S882** - P. 314
L 85 x H 73,4 cm

Art. **S883** - P. 314
L 95 x H 73,4 cm

Art. **S876** - P. 314
L 105 x H 61,2 cm

Art. **S877** - P. 314
L 120 x H 61,2 cm

Art. **S878** - P. 314
L 130 x H 61,2 cm

Art. **S879** - P. 314
L 140 x H 61,2 cm

Art. **S884** - P. 314
L 105 x H 73,4 cm

Art. **S885** - P. 314
L 120 x H 73,4 cm

Art. **S886** - P. 314
L 130 x H 73,4 cm

Art. **S887** - P. 314
L 140 x H 73,4 cm

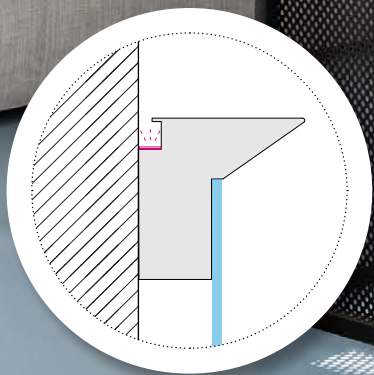

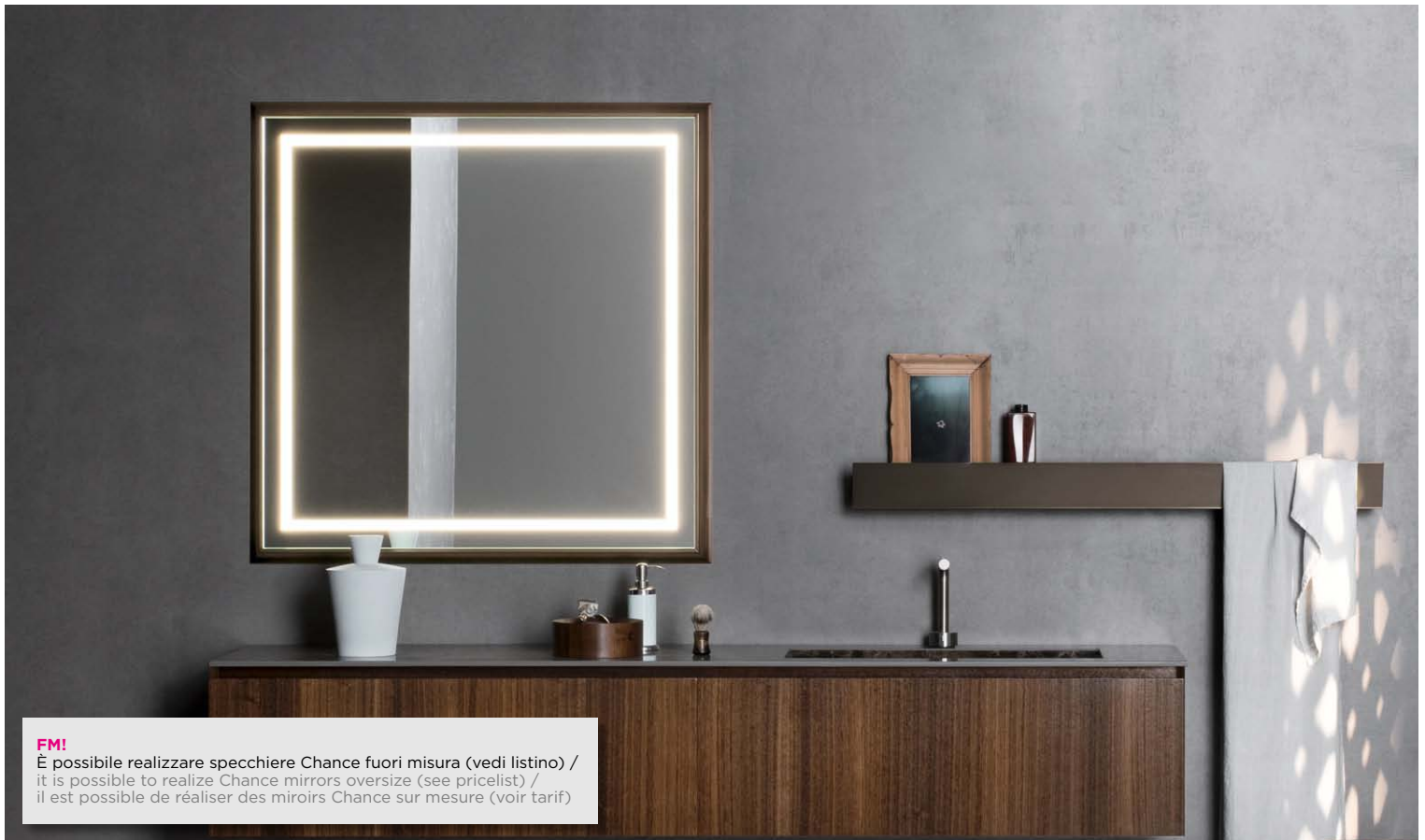
**FM!**

È possibile realizzare specchiere Chance fuori misura (vedi listino) /
it is possible to realize Chance mirrors oversize (see pricelist) /
il est possible de réaliser des miroirs Chance sur mesure (voir tarif)

Chance

Specchiera CHANCE con profilo in alluminio. Specchio con serigrafia satinata e luce led perimetrale interna /
Mirror CHANCE with aluminium frame. Mirror with silkscreen-printing and led internal perimeter light /
Miroir CHANCE avec profil en aluminium. Miroir avec sérigraphie satinée et éclairage à led périmétral interne.

Spessore 4,5 cm / Thick 4,5 cm / Épaisseur 4,5 cm

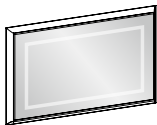

FINITURE

Nero
ossidato

Rodio
lucido

Non è possibile aggiungere faretto alla specchiera /
No spotlight available for this mirror /
Il est impossible d'ajouter des spots au miroir

Art. **S854** - P. 315
L 60 x H 61,2 cm

Art. **S855** - P. 315
L 70 x H 61,2 cm

Art. **S856** - P. 315
L 85 x H 61,2 cm

Art. **S857** - P. 315
L 95 x H 61,2 cm

Art. **S862** - P. 315
L 60 x H 73,4 cm

Art. **S863** - P. 315
L 70 x H 73,4 cm

Art. **S864** - P. 315
L 85 x H 73,4 cm

Art. **S865** - P. 315
L 95 x H 73,4 cm

Art. **S858** - P. 315
L 105 x H 61,2 cm

Art. **S859** - P. 315
L 120 x H 61,2 cm

Art. **S860** - P. 315
L 130 x H 61,2 cm

Art. **S861** - P. 315
L 140 x H 61,2 cm

Art. **S866** - P. 315
L 105 x H 73,4 cm

Art. **S867** - P. 315
L 120 x H 73,4 cm

Art. **S868** - P. 315
L 130 x H 73,4 cm

Art. **S869** - P. 315
L 140 x H 73,4 cm

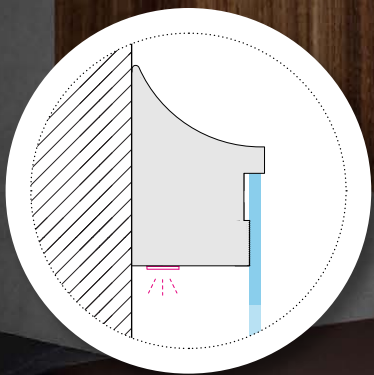

**FM!**

È possibile realizzare specchiere Slim fuori misura (vedi listino) /
it is possible to realize Slim mirrors oversize (see pricelist) /
il est possible de réaliser des miroirs Slim sur mesure (voir tarif)

Slim

Specchiera SLIM con profilo in alluminio /
Mirror SLIM with aluminium frame /
miroir SLIM avec profil en aluminium.

Spessore 4,5 cm / Thick 4,5 cm / Épaisseur 4,5 cm

FINITURE

Nero
ossidato

Rodio
lucido

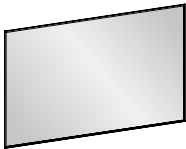

Non è possibile aggiungere faretto alla specchiera /
No spotlight available for this mirror /
Il est impossible d'ajouter des spots au miroir

Art. **S783** - P. 316
L 60 x H 61,2 cm

Art. **S784** - P. 316
L 70 x H 61,2 cm

Art. **S785** - P. 316
L 85 x H 61,2 cm

Art. **S786** - P. 316
L 95 x H 61,2 cm

Art. **S791** - P. 316
L 60 x H 73,4 cm

Art. **S792** - P. 316
L 70 x H 73,4 cm

Art. **S793** - P. 316
L 85 x H 73,4 cm

Art. **S794** - P. 316
L 95 x H 73,4 cm

Art. **S787** - P. 316
L 105 x H 61,2 cm

Art. **S788** - P. 316
L 120 x H 61,2 cm

Art. **S789** - P. 316
L 130 x H 61,2 cm

Art. **S790** - P. 316
L 140 x H 61,2 cm

Art. **S795** - P. 316
L 105 x H 73,4 cm

Art. **S796** - P. 316
L 120 x H 73,4 cm

Art. **S797** - P. 316
L 130 x H 73,4 cm

Art. **S798** - P. 316
L 140 x H 73,4 cm

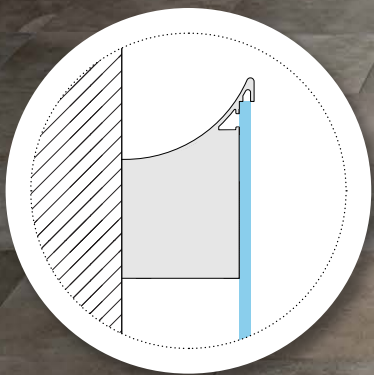

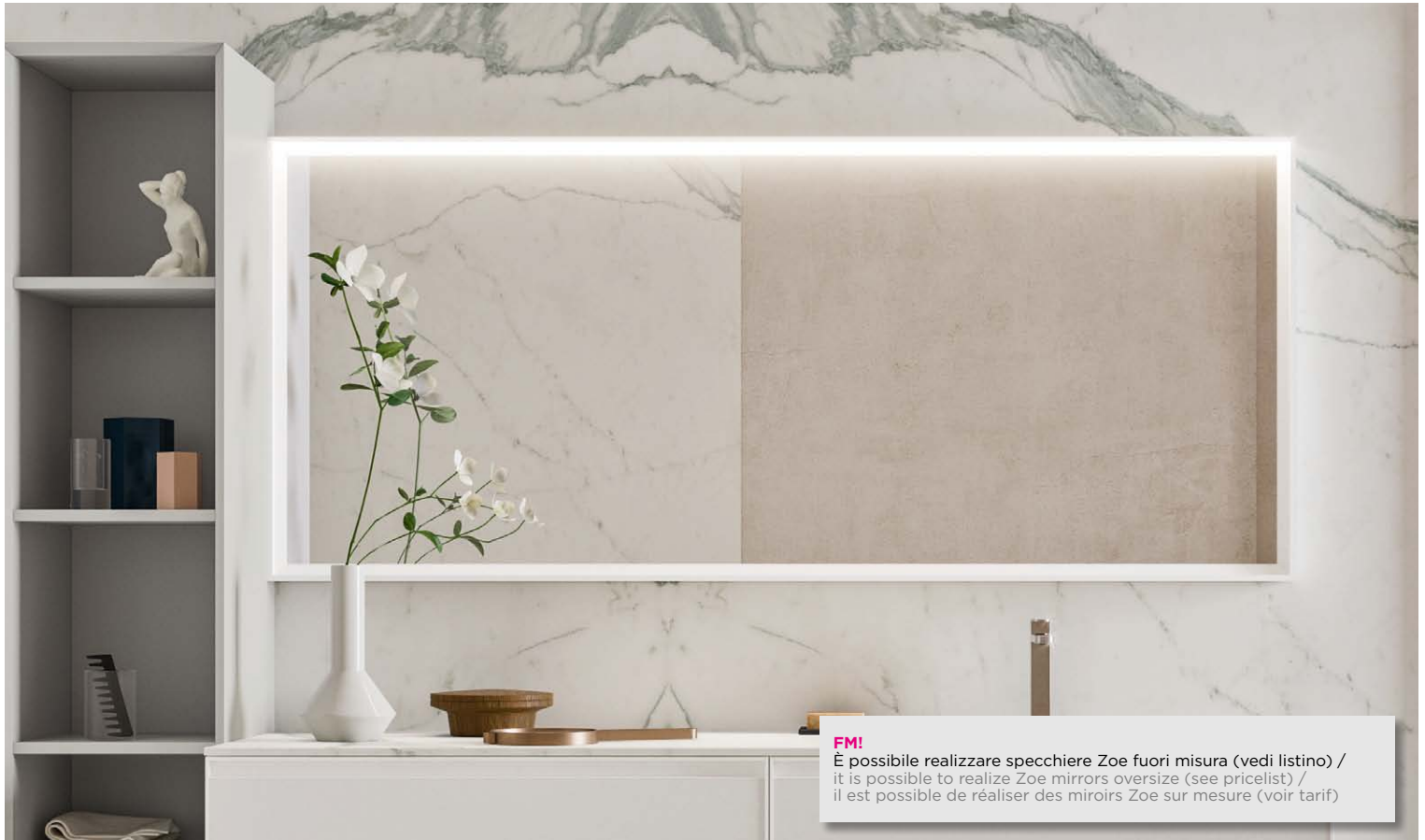
**FM!**

È possibile realizzare specchiere Zoe fuori misura (vedi listino) /
it is possible to realize Zoe mirrors oversize (see pricelist) /
il est possible de réaliser des miroirs Zoe sur mesure (voir tarif)

Zoe

Specchiera ZOE con profilo in alluminio. Parte superiore con led integrato.
Luce led posteriore sopra e sotto. /
Mirror ZOE with aluminium frame. Top part with built-in internal led light.
Rear led light above and below /
Miroir ZOE avec profil en aluminium. Partie supérieure avec led intégré interne.
Éclairage à led derrière dessus et dessous.

Spessore 6,2 cm / Thick 6,2 cm / Épaisseur 6,2 cm

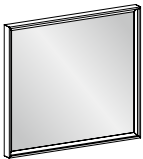
**FINITURA**

Nero
ossidato
(di serie)

FINITURA FM

Bianco
opaco

Non è possibile aggiungere faretti alla specchiera /
No spotlight available for this mirror /
Il est impossible d'ajouter des spots au miroir

Art. **S627** - P. 317
L 70 x H 73,4 cm

Art. **S628** - P. 317
L 85 x H 73,4 cm

Art. **S629** - P. 317
L 120 x H 73,4 cm

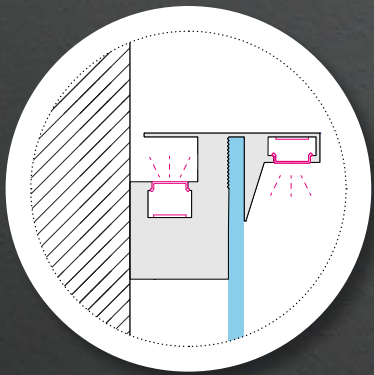



Scia

Specchiera SCIA con profilo rivestito e fascia serigrafata e retroilluminata /
 SCIA mirror with aluminium coated profile, screen-printed screen and backlighting /
 miroir SCIA avec profil revêtu en aluminium et bande sérigraphiée et rétro-éclairé

Spessore 3 cm / Thick 3 cm / Épaisseur 3 cm

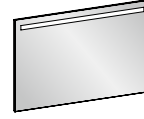

Art. **S901** - P. 318
 L 95 x H 61,2 cm

Art. **S902** - P. 318
 L 95 x H 73,4 cm

Art. **S903** - P. 318
 L 105 x H 61,2 cm

Art. **S904** - P. 318
 L 105 x H 73,4 cm

Art. **S905** - P. 318
 L 120 x H 61,2 cm

Art. **S906** - P. 318
 L 120 x H 73,4 cm

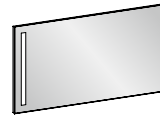

Art. **S907** - P. 318
 L 95 x H 61,2 cm

Art. **S908** - P. 318
 L 95 x H 73,4 cm

Art. **S909** - P. 318
 L 105 x H 61,2 cm

Art. **S910** - P. 318
 L 105 x H 73,4 cm

Art. **S911** - P. 318
 L 120 x H 61,2 cm

Art. **S912** - P. 318
 L 120 x H 73,4 cm





Pulsar

Specchiera PULSAR con profilo in alluminio e luce LED sopra (su fascia satinata H 3,5 cm). Con interruttore touch (posizione fissa a DX) / PULSAR mirror with aluminium profile and LED light above (on satin-finished strip, H. 3.5 cm). With touch switch (fixed on RHS) / miroir PULSAR avec profil en aluminium et éclairage à LED au dessus (sur bande satiné H 3,5 cm). Avec interrupteur touch (position fixe à droite).

Spessore 2,6 cm / Thick 2,6 cm / Épaisseur 2,6 cm

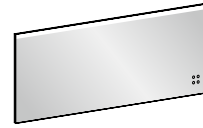

Art. **S495** - P. 320
L 85 x H 73,4 cm

Art. **S496** - P. 320
L 95 x H 73,4 cm

Art. **S497** - P. 320
L 105 x H 73,4 cm

Art. **S498** - P. 320
L 120 x H 73,4 cm

Art. **S499** - P. 320
L 130 x H 73,4 cm

Art. **S500** - P. 320
L 140 x H 73,4 cm

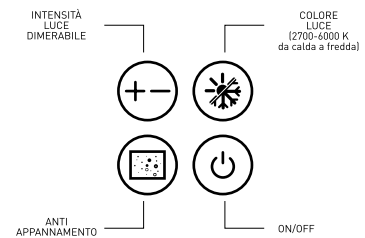

Krea

Specchiera KREA con profilo in alluminio e luce LED sopra e sotto / KREA mirror with aluminium profile and LED light above and below / miroir KREA avec profil en aluminium et éclairage à LED au dessus et dessous

Spessore 2,6 cm / Thick 2,6 cm / Épaisseur 2,6 cm

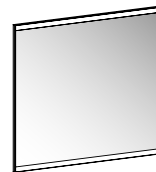

Art. **S487** - P. 320
L 60 x H 73,4 cm

Art. **S488** - P. 320
L 70 x H 73,4 cm

Art. **S489** - P. 320
L 85 x H 73,4 cm

Art. **S490** - P. 320
L 95 x H 73,4 cm

Art. **S491** - P. 320
L 105 x H 73,4 cm

Art. **S492** - P. 320
L 120 x H 73,4 cm

Art. **S493** - P. 320
L 130 x H 73,4 cm

Art. **S494** - P. 320
L 140 x H 73,4 cm





Piper

Specchiera PIPER con profilo in legno e doppia illuminazione LED integrata sopra e sotto /
 PIPER mirror with wooden profile and integrated LED lighting above and below /
 miroir PIPER avec profil en bois et double éclairage à LEDS intégré dessus et dessous

Spessore 6 cm / Thick 6 cm / Épaisseur 6 cm

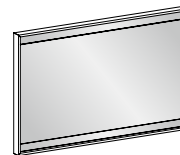

Art. **S913** - P. 321
 L 70 x H 73,4 cm

Art. **S914** - P. 321
 L 85 x H 73,4 cm

Art. **S915** - P. 321
 L 95 x H 73,4 cm

Art. **S351** - P. 321
 L 105 x H 73,4 cm

Art. **S916** - P. 321
 L 120 x H 73,4 cm

Art. **S917** - P. 321
 L 130 x H 73,4 cm

Art. **S918** - P. 321
 L 140 x H 73,4 cm

Bishop

Specchiera BISHOP con profilo in alluminio BRILL o alluminio rivestito rovere. Luce led perimetrale integrata. Orizzontale-Verticale /
 BISHOP mirror with aluminium or oak-coated aluminium profile. Integrated perimeter LED light. Horizontal-Vertical./
 miroir BISHOP avec profil en aluminium BRILL ou aluminium revêtu en chêne. Éclairage à led périmétral intégré. Horizontal-Vertical.

Spessore 4,5 cm / Thick 4,5 cm / Épaisseur 4,5 cm

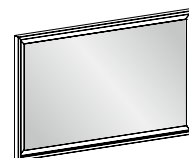

Art. **S919** - P. 321
 L 60 x H 73,4 cm

Art. **S920** - P. 321
 L 70 x H 73,4 cm

Art. **S921** - P. 321
 L 85 x H 73,4 cm

Art. **S922** - P. 321
 L 95 x H 73,4 cm

Art. **S923** - P. 321
 L 105 x H 73,4 cm

Art. **S924** - P. 321
 L 120 x H 73,4 cm

Art. **S925** - P. 321
 L 130 x H 73,4 cm

Art. **S350** - P. 321
 L 140 x H 73,4 cm



Lucy

Specchiera LUCY con unione a 45° e luce led integrata. Orizz./Vert. /
LUCY mirror with 45° joint and built-in LED light. Horiz./Vert. /
miroir LUCY avec union à 45° et éclairage à LEDS intégré. Horiz./
Vert.

Spessore 6 cm / Thick 6 cm / Épaisseur 6 cm

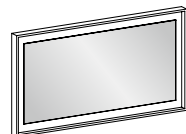

Art. **S670** - P. 322
L 70 x H 61,2 cm

Art. **S671** - P. 322
L 85 x H 61,2 cm

Art. **S672** - P. 322
L 95 x H 61,2 cm

Art. **S673** - P. 322
L 105 x H 61,2 cm

Art. **S674** - P. 322
L 120 x H 61,2 cm

Art. **S675** - P. 322
L 130 x H 61,2 cm

Art. **S676** - P. 322
L 140 x H 61,2 cm

Art. **S677** - P. 322
L 70 x H 170 cm

Art. **S678** - P. 322
L 70 x H 193,2 cm



Gabry

Specchiera GABRY con unione a 45° e luce led integrata. Orizz./
Vert. /
GABRY mirror with 45° joint and built-in LED light. Horiz./Vert. /
miroir GABRY avec union à 45° et éclairage à LEDS intégré Horiz./
Vert.

Spessore 15 cm / Thick 15 cm / Épaisseur 15 cm

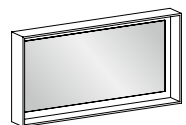

Art. **S253** - P. 322
L 70 x H 61,2 cm

Art. **S254** - P. 322
L 85 x H 61,2 cm

Art. **S255** - P. 322
L 95 x H 61,2 cm

Art. **S256** - P. 322
L 105 x H 61,2 cm

Art. **S272** - P. 322
L 120 x H 61,2 cm

Art. **S273** - P. 322
L 130 x H 61,2 cm

Art. **S274** - P. 322
L 140 x H 61,2 cm



Maison

Specchiera MAISON con specchio bisellato e cornice in legno massiccio /
 MAISON mirror with bevelled edge and frame in solid wood /
 miroir MAISON avec miroir biseauté et cadre en bois massif

Spessore 2,2 cm / Thick 2,2 cm / Épaisseur 2,2 cm

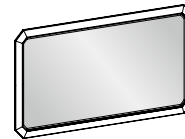

Art. **S427** - P. 323
 L 95 x H 73,4 cm

Art. **S428** - P. 323
 L 105 x H 73,4 cm

Art. **S429** - P. 323
 L 140 x H 73,4 cm

Woodline

Specchiera WOODLINE con cornice in alluminio con legno applicato L 1 cm /
 WOODLINE mirror with aluminium frame with wood applied W 1 cm /
 miroir WOODLINE avec cadre en aluminium avec bois appliqué L 1 m

Spessore 3,1 cm / Thick 3,1 cm / Épaisseur 3,1 cm

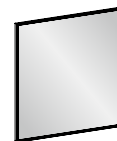

Art. **S473** - P. 323
 L 60 x H 73,4 cm

Art. **S474** - P. 323
 L 70 x H 73,4 cm

Art. **S475** - P. 323
 L 85 x H 73,4 cm

Art. **S476** - P. 323
 L 95 x H 73,4 cm

Art. **S477** - P. 323
 L 105 x H 73,4 cm

Art. **S478** - P. 323
 L 120 x H 73,4 cm

Art. **S479** - P. 323
 L 130 x H 73,4 cm

Art. **S480** - P. 323
 L 140 x H 73,4 cm



Tray

Specchiera TRAY con telaio in alluminio e cornice specchio. Orizz./Vert. /
 TRAY mirror with aluminium structure and mirrored frame. Horiz./Vert. /
 miroir TRAY avec cadre en aluminium et cadre miroir biseauté. Horiz./Vert.

Spessore 3,1 cm / Thick 3,1 cm / Épaisseur 3,1 cm

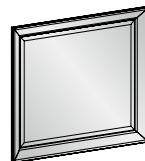

Art. **S138** - P. 324
 L 70 x H 73,4 cm

Art. **S139** - P. 324
 L 85 x H 73,4 cm

Art. **S230** - P. 324
 L 95 x H 73,4 cm

Art. **S231** - P. 324
 L 105 x H 73,4 cm

Art. **S232** - P. 324
 L 120 x H 73,4 cm



Augusto

Specchiera AUGUSTO con cornice in legno L 8 cm. Orizz./Vert. /
 AUGUSTO mirror with wood frame W 8 cm. Horiz./Vert. /
 miroir AUGUSTO avec cadre en bois L 8 cm. Horiz./Vert.

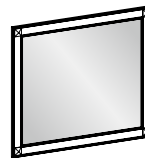

Art. **S339** - P. 324
 L 70 x H 95 cm

Art. **S340** - P. 324
 L 85 x H 95 cm

Art. **S341** - P. 324
 L 95 x H 95 cm

Art. **S342** - P. 324
 L 105 x H 95 cm

Art. **S343** - P. 324
 L 120 x H 95 cm



Round

Specchiera ROUND in metallo nero, con asta estetica H 42,5 cm regolabile in altezza (H 57 cm max.) /
 ROUND mirror in black metal, with H. 42,5 cm decorative rod, height adjustable (max H. 57 cm) /
 Miroir ROUND en métal noir, avec esthétique tige H 42,5 cm réglable en hauteur (H. max 57 cm).

Spessore 4 cm / Thick 4 cm / Épaisseur 4 cm

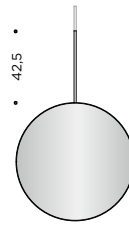

Art. **S243** - P. 319
 L 70 x H 70 cm

(senza interruttore / no switch / sans interrupteur)



Forma

Specchiera FORMA direzionabile in metallo nero, con asta estetica H 35 cm regolabile in altezza (H 50 cm max.) /
 FORMA directional mirror in black metal, with H. 35 cm decorative rod, height adjustable (max H. 50 cm) /
 Miroir FORMA orientable en métal noir, avec esthétique tige H 35 cm réglable en hauteur (H. max 50 cm).

Spessore 4 cm / Thick 4 cm / Épaisseur 4 cm

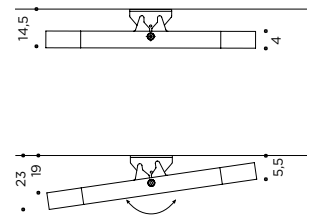

Art. **S130** - P. 319
 L 50 x H 100 cm

(senza interruttore / no switch / sans interrupteur)







Light tonda

Specchiera LIGHT tonda /
round LIGHT mirror /
miroir Light tonda

Spessore 2,2 cm / Thick 2,2 cm / Épaisseur 2,2 cm

Optional: luce led perimetrale /
On demand: perimeter led
Sur demande: éclairage à leds périmétral



Art. **S268** - P. 327
ø 30 cm

Art. **S269** - P. 327
ø 40 cm

Senza faretto /
without spotlight /
sans spot

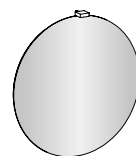

Art. **S113** - P. 327
ø 68 cm

Art. **S112** - P. 327
ø 85 cm

Art. **S278** - P. 327
ø 100 cm

Con faretto THUNDER (V832) di serie /
with standard spotlight THUNDER (V832) /
avec spot THUNDER (V832) de série



Sole

Specchiera SOLE dx-sx /
SOLE mirror rh-lh /
miroir SOLE droit-gauche

Spessore 2,7 cm / Thick 2,7 cm / Épaisseur 2,7 cm

Optional: luce led perimetrale /
On demand: perimeter led
Sur demande: éclairage à leds périmétral

Faretto di serie OFF art. V055 o led perimetrale /
standard spotlight OFF art.V055 or perimeter led light /
spot OFF art. V055 de série ou éclairage à leds périmétral

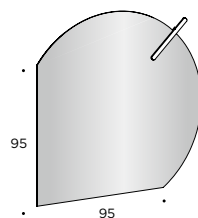

Art. **S128** - P. 329
L 123,5 x H 123,5 cm



Stone

Spessore 2,2 cm / Thick 2,2 cm / Épaisseur 2,2 cm

Specchiera STONE orizzontale o verticale con bisello 2 cm / horizontally or vertically-fitted Light STONE with 2 cm bevelling / miroir STONE horizontal ou vertical avec biseau de 2 cm

Faretto di serie THUNDER (art. V832) o luce LED perimetrale / standard spotlight THUNDER (V832) or perimetral led light / avec spot THUNDER (V832) de série or éclairage à leds périmétral

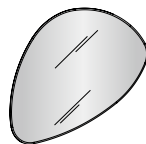

con luce **LED** - P. 326

Art. **S101** L 105 x H 88 cm
(senza interruttore /
no switch / sans interrupteur)



con luce **LED** - P. 326

Art. **S102** L 88 x H 105 cm
(senza interruttore /
no switch / sans interrupteur)

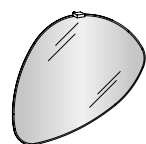

con faretto **THUNDER** - P. 326

Art. **S301** L 105 x H 88 cm
(senza interruttore /
no switch / sans interrupteur)



con faretto **THUNDER** - P. 326

Art. **S302** L 88 x H 105 cm
(senza interruttore /
no switch / sans interrupteur)



Stone piccola

Spessore 2,2 cm / Thick 2,2 cm / Épaisseur 2,2 cm

Specchiera STONE PICCOLA orizzontale o verticale con bisello 2 cm / horizontally or vertically-fitted Light STONE PICCOLA with 2 cm bevelling / miroir STONE PICCOLA horizontal ou vertical avec biseau de 2 cm

Faretto di serie THUNDER (art. V832) o luce LED perimetrale / standard spotlight THUNDER (V832) or perimetral led light / avec spot THUNDER (V832) de série or éclairage à leds périmétral

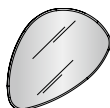

con luce **LED** - P. 326

Art. **S203** L 78 x H 66 cm
(senza interruttore /
no switch / sans interrupteur)



con luce **LED** - P. 326

Art. **S204** L 66 x H 78 cm
(senza interruttore /
no switch / sans interrupteur)

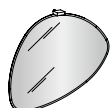

con faretto **THUNDER** - P. 326

Art. **S103** L 78 x H 66 cm
(senza interruttore /
no switch / sans interrupteur)



con faretto **THUNDER** - P. 326

Art. **S104** L 66 x H 78 cm
(senza interruttore /
no switch / sans interrupteur)







Fancy 80 - led perimetrale

Spessore 2,2 cm / Thick 2,2 cm / Épaisseur 2,2 cm

Specchiera FANCY con luce led perimetrale /
FANCY mirror with perimeter LED light /
miroir FANCY avec éclairage a LEDS périmétral

Optional: luce led perimetrale /
On demand: perimeter led
Sur demande: éclairage à leds périmétral

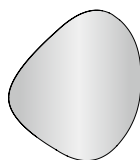

con luce **LED** / with **LED** / avec **LED**

Art. **S277** L 80 x H 80 cm - P. 327
(senza interruttore / no switch / sans interrupteur)



Fancy 40

Spessore 2,2 cm / Thick 2,2 cm / Épaisseur 2,2 cm

Specchiera FANCY senza luce led perimetrale /
FANCY mirror without perimeter LED light /
miroir FANCY sans éclairage a LEDS périmétral

Optional: luce led perimetrale /
On demand: perimeter led
Sur demande: éclairage à leds périmétral



Art. **S276** L 40 x H 40 cm - P. 327
(senza interruttore / no switch / sans interrupteur)



Fancy 80 - faretto ON

Spessore 2,2 cm / Thick 2,2 cm / Épaisseur 2,2 cm

Specchiera FANCY con faretto led ON (V054) di serie /
FANCY mirror with ON led spotlight (V054) as standard /
miroir FANCY avec led spot ON (V054) de série

Optional: luce led perimetrale /
On demand: perimeter led
Sur demande: éclairage à leds périmétral

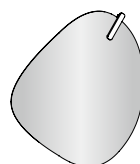

Art. **S280** L 80 x H 80 cm - P. 327
(senza interruttore / no switch / sans interrupteur)





Sail

Specchiera SAIL /
SAIL mirror /
miroir SAIL

Spessore 2,2 cm / Thick 2,2 cm / Épaisseur 2,2 cm

Faretto di serie THUNDER art. V832 /
standard spotlight THUNDER art. V832 /
spot THUNDER art. V832 de série

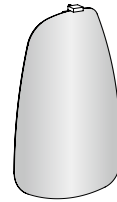

Art. **S303** - p. 329
L **66/43** x H **105** cm

(senza interruttore / no switch / sans interrupteur)



Cuore

Specchiera CUORE /
CUORE mirror /
miroir CUORE

Spessore 2,2 cm / Thick 2,2 cm / Épaisseur 2,2 cm

Faretto di serie ON art. V054 /
standard led spotlight ON art.V054 /
leds spot ON art. V054 de série

Optional: luce led perimetrale /
On demand: perimeter led
Sur demande: éclairage à leds périmétral

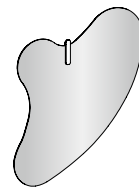

Art. **S090** - p. 329
L **85** x H **100** cm

(senza interruttore / no switch / sans interrupteur)



Charme

Specchiera CHARME orizzontale o verticale con bisello /
CHARME mirror horizontal or vertical with bevelled edge /
Miroir CHARME horizontal ou vertical avec biseau

Spessore 2,2 cm / Thick 2,2 cm / Épaisseur 2,2 cm

Optional: luce led perimetrale /
On demand: perimeter led
Sur demande: éclairage à led périmétral



Art. **S122** - P. 328
L 60 x H 105 cm

(senza interruttore / no switch / sans interrupteur)



Retrò

Specchiera RETRÒ orizzontale o verticale con bisello /
RETRÒ mirror horizontal or vertical with bevelled edge /
Miroir RETRÒ horizontal ou vertical avec biseau

Spessore 2,2 cm / Thick 2,2 cm / Épaisseur 2,2 cm

Optional: luce led perimetrale /
On demand: perimeter led
Sur demande: éclairage à led périmétral

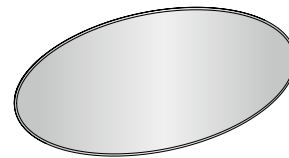

Art. **S040** - P. 328
L 160 x H 70 cm

(senza interruttore / no switch / sans interrupteur)



Olimpia

Specchiera OLIMPIA in legno curvato sp. 7/3,5 cm /
OLIMPIA mirror in curved wood, 7/3,5 cm thick /
miroir OLIMPIA avec en bois arrondi ép. 7/3,5 cm

Optional: luce led perimetrale /
On demand: perimeter led
Sur demande: éclairage à led périmétral

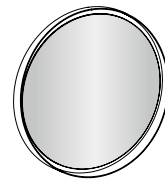

Art. **S413** - P. 328
L 90 x H 90 cm
(senza interruttore / no switch / sans interrupteur)



Pliè

Specchiera PLIÈ in metallo bianco opaco sp. 7/2,7 cm /
PLIÈ mirror in matt white metal, 7/2,7 cm thick /
miroir PLIÈ en métal blanc mat ép. 7/2,7 cm

Optional: luce led perimetrale /
On demand: perimeter led
Sur demande: éclairage à led périmétral



Art. **S414** - P. 328
L 60 x H 60 cm
(senza interruttore / no switch / sans interrupteur)



Play

Specchiera PLAY con cornice in vetro curvato e argentato a mano.
Specchio interno L 70 x H 70 cm /
PLAY mirror with curved mirror frame, silvered by hand. Actual
mirror W 70 x H 70 cm. /
miroir PLAY avec cadre en verre arrondi et argenté à main. Miroir
interne L 70 x H 70 cm

Faretto di serie GENIUS led art. 6948 /
standard spotlight GENIUS led item 6948 /
spot GENIUS led art. 6948

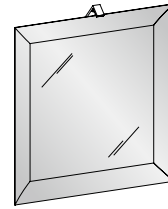

Art. **S226** - P. 325
L 90 x H 90 cm

(senza interruttore / no switch / sans interrupteur)

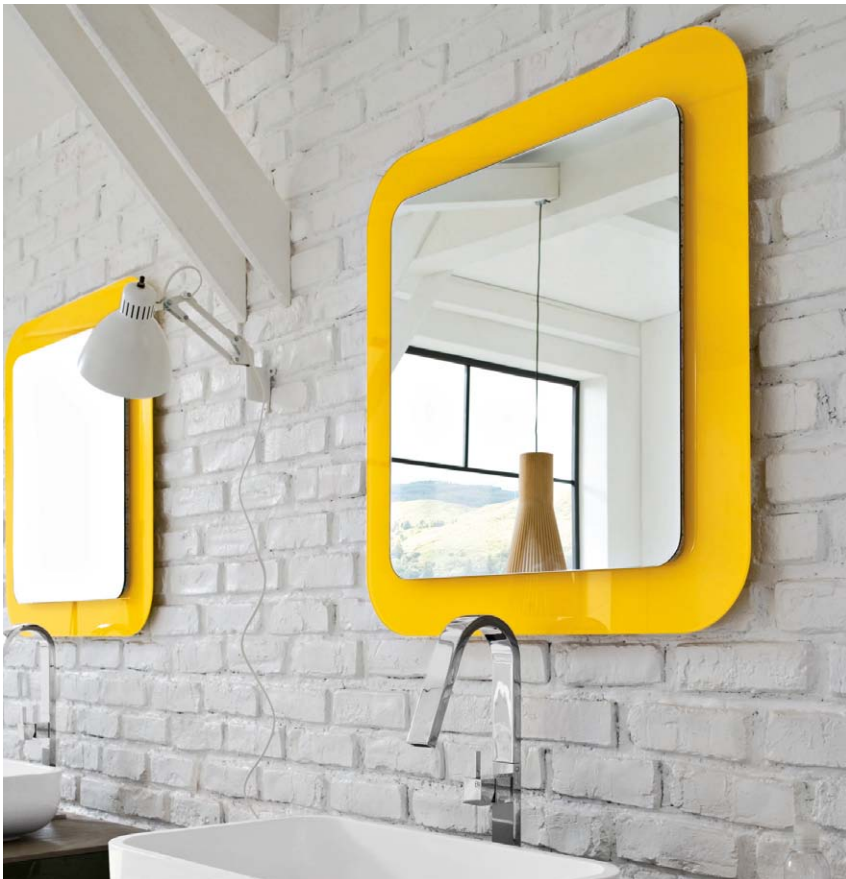

Jolly

Specchiera JOLLY orizzontale o verticale con cornice in vetro nei
colori della Mazzetta 2019. Luce led integrata. /
JOLLY mirror horizontal or vertical with glass frame in the colours of
the 2019 Palette, built-in led light /
miroir JOLLY horizontal ou vertical avec cadre en verre dans les
coloris de la palette 2019. Éclairage à leds intégré

Spessore 2,6 cm / Thick 2,6 cm / Épaisseur 2,6 cm

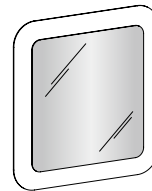

Art. **S167** - P. 329
L 70 x H 73,4 cm

(interruttore sotto / switch on the bottom / interrupteur en
dessous)

Art. **S168** - P. 329
L 105 x H 73,4 cm

(interruttore sotto o destra / switch on the bottom or rh /
interrupteur en dessous ou à droite)





Bon Bon

Specchiera BON BON con cornice a specchio curvato e argentato a mano.

Specchio interno L 80 x H 50 cm /

BON BON mirror with curved mirror frame, silvered by hand.

Actual mirror W 80 x H 50 cm /

miroirs BON BON avec cadre à miroir, arrondi et argenté à main.

Miroir interne L 80 x H 50 cm

Optional: luce led perimetrale /

On demand: perimeter led

Sur demande: éclairage à led périmétral

Spessore 5 cm / Thick 5 cm / Épaisseur 5 cm

Art. **SV02** - P. 330

L 100 x H 69 cm

(senza interruttore / no switch / sans interrupteur)



Diamante

Specchiera DIAMANTE orizzontale o verticale con frammenti di vetro argentato.

Specchio interno L 40 x H 70 cm /

DIAMANTE mirror horizontal or vertical with fragments of silvered glass.

Actual mirror W 40 x H 70 cm /

miroir DIAMANTE horizontal ou vertical avec fragments de verre argenté.

Miroir interne L 40 x H 70 cm.

Spessore 2 cm / Thick 2 cm / Épaisseur 2 cm

Art. **S121** - P. 330

L 60 x H 90 cm

(senza interruttore / no switch / sans interrupteur)



Rose

Specchiera ROSE con cornice in faggio laccato opaco, velvet o metal. Orizzontale o verticale. Specchio interno L 53 x H 93 cm / ROSE mirror with matt, velvet or metal lacquered beech frame. Horizontal or vertical. Actual mirror W 53 x H 93 cm / miroir ROSE avec cadre en hêtre laque mat, velvet ou metal. Horizontal ou vertical. Miroir interne L 53 x H 93 cm

Optional: luce led perimetrale /
On demand: perimeter led
Sur demande: éclairage à led périmétral



Art. **S048** - P. 330
L 80 x H 120 cm

(senza interruttore / no switch / sans interrupteur)



Kent

Specchiera KENT con cornice in faggio laccato opaco, velvet o metal. Specchio interno ø 58 cm / KENT mirror with matt, velvet or metal lacquered beech frame. Actual mirror ø 58 cm / miroir KENT avec cadre en hêtre laque mat, velvet ou metal. Miroir interne ø 58 cm

Optional: luce led perimetrale /
On demand: perimeter led
Sur demande: éclairage à leds périmétral



Art. **S080** - P. 330
ø 85 cm

(senza interruttore / no switch / sans interrupteur)





Antibes

Specchiera ANTIBES con cornice in faggio laccato opaco, velvet o metal.
 Specchio interno L 60 cm /
 ANTIBES mirror with matt, velvet or metal lacquered beech frame.
 Internal mirror W 60 cm /
 miroir ANTIBES avec cadre en hêtre laque mat, velvet ou metal.
 Miroir interne L 60 cm

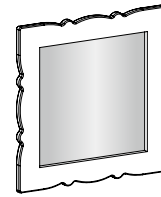

Art. **S463** - P. 331
 L 80 x H 80 cm

(senza interruttore / no switch / sans interrupteur)



Provence

Specchiera PROVENCE con cornice in faggio laccato opaco, velvet o metal. Specchio interno L 105 x H 53 cm /
 PROVENCE mirror with matt, velvet or metal lacquered beech frame. Internal mirror W 105 x H 53 cm /
 miroir PROVENCE avec cadre en hêtre laqué mat, velvet ou metal.
 Miroir interne L 105 x H 53 cm



Art. **S464** - P. 331
 L 132 x H 80 cm

(senza interruttore / no switch / sans interrupteur)





Libra

Specchiera LIBRA con bisello e perni cromati basculanti /
LIBRA mirror with bevelled edge and chrome tilting joints /
miroir LIBRA avec biseau et axes chromés basculants

Spessore 8,5 cm / Thick 8,5 cm / Épaisseur 8,5 cm
Sporgenza perni 7,3 cm / Pivot overhang W 7,3 cm / Épaisseur 8,5 cm

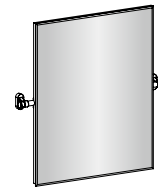

Art. **S186** - P. 325
L 60 x H 73,4 cm

Art. **S187** - P. 325
L 70 x H 73,4 cm







Side

Specchiera SIDE con faretto Flash art. V818 led di serie e specchi interni /
SIDE mirror-fronted cabinet standard with Flash spotlight item V818 and internal mirrors /
miroir SIDE avec spot Flash à led art. V818 de série et miroirs internes

Profondità 18 cm / Depth 18 cm / Épaisseur 18 cm

Finiture / finishes / finitions:
vedi listino Modelli 2019, pag. 333
see Modelli 2019 pricelist, page 333
voir tarif Modelli 2019, pag. 333

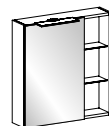

Art. **S540** - P. 333
L 70 x H 73,4 cm

Art. **S541** - P. 333
L 85 x H 73,4 cm

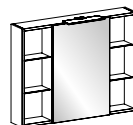

Art. **S542** - P. 333
L 95 x H 73,4 cm

Art. **S543** - P. 333
L 105 x H 73,4 cm

Art. **S544** - P. 333
L 120 x H 73,4 cm

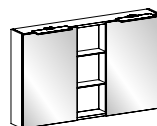

Art. **S566** - P. 333
L 120 x H 73,4 cm

Art. **S545** - P. 333
L 140 x H 73,4 cm



Diva

Specchiera DIVA con faretto Flash art. V818 led di serie, specchi interni e spot-led/
 DIVA mirror-fronted cabinet standard with Flash spotlight item V818, internal mirrors and spot led /
 miroir DIVA avec spot Flash à led art. V818 de série, miroirs internes et spot leds.

Profondità 18 cm / Depth 18 cm / Épaisseur 18 cm

Finiture / finishes / finitions:
 vedi listino Modelli 2019, pag. 333
 see Modelli 2019 pricelist, page 333
 voir tarif Modelli 2019, pag. 333

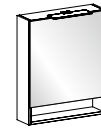

Art. **S546** - p. 333
 L 60 x H 73,4 cm

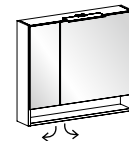

Art. **S547** - p. 333
 L 70 x H 73,4 cm

Art. **S548** - p. 333
 L 85 x H 73,4 cm

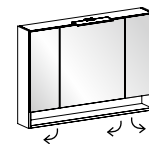

Art. **S549** - p. 333
 L 95 x H 73,4 cm

Art. **S550** - p. 333
 L 105 x H 73,4 cm

Art. **S551** - p. 333
 L 120 x H 73,4 cm



Sintesi

Specchiera SINTESI con faretto Flash art. V818 led di serie e specchi interni /
 SINTESI mirror-fronted cabinet standard with Flash spotlight item V818 and internal mirrors /
 miroir SINTESI avec spot Flash à led art. V818 de série et miroirs internes

Profondità 18 cm / Depth 18 cm / Épaisseur 18 cm

Finiture / finishes / finitions:
 vedi listino Modelli 2019, pag. 332
 see Modelli 2019 pricelist, page 332
 voir tarif Modelli 2019, pag. 332

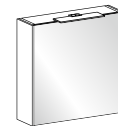

Art. **S552** - p. 332
 L 62,4 x H 61,2 cm

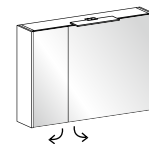

Art. **S553** - p. 332
 L 72,4 x H 61,2 cm

Art. **S554** - p. 332
 L 87,4 x H 61,2 cm

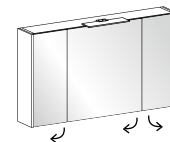

Art. **S555** - p. 332
 L 97,4 x H 61,2 cm

Art. **S556** - p. 332
 L 107,4 x H 61,2 cm

Art. **S557** - p. 332
 L 122,4 x H 61,2 cm



Plus

Specchiera contenitore PLUS con 2 spot led /
 PLUS mirror with 2 LED spotlights /
 Miroir de rangement PLUS avec 2 spots led

Profondità 18 cm / Depth 18 cm / Épaisseur 18 cm

Finiture / finishes / finitions:
 vedi listino Modelli 2019 pag. 332
 see Modelli 2019 pricelist, page 332
 voir tarif Modelli 2019, pag. 332

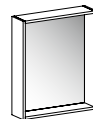

Art. **S365** - P. 332
 L 60 x H 73,4 x P 16 cm

Art. **S366** - P. 332
 L 70 x H 73,4 x P 16 cm

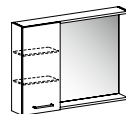

Art. **S367** - P. 332
 L 95 x H 73,4 cm

Art. **S368** - P. 332
 L 105 x H 73,4 cm

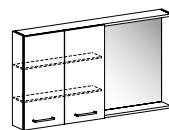

Art. **S369** - P. 332
 L 130 x H 73,4 cm

Art. **S370** - P. 332
 L 140 x H 73,4 cm



SPOTLIGHTS

SPOTS

FARETTI



Metro

Faretto a luce led completo di alimentatore separato /
Led spotlight complete with separate power supply /
Spot avec éclairage à led avec alimentateur séparé

4000 K (luce naturale / natural light / lumière naturelle)

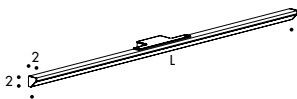

Art. **6943** - P. 335

L / W / L **70** cm

7 W - 12 V - 280 lux

Art. **6944** - P. 335

L / W / L **95** cm

9 W - 12 V - 330 lux

Art. **6945** - P. 335

L / W / L **120** cm

12 W - 12 V - 360 lux

Art. **6956** - P. 335

L / W / L **140** cm

14 W - 12 V - 390 lux

Art. **6957** - P. 335

L / W / L **175** cm

17 W - 12 V - 400 lux



Trail

Faretto a luce led con alimentatore separato /
Led spotlight complete with separate power supply /
Spot avec éclairage à led avec alimentateur intégré

4000 K (luce naturale / natural light / lumière naturelle)

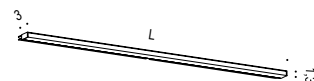

Art. **V167** - P. 335

L / W / L **40** cm

10 W - 330 lux - 230 V

Art. **V168** - P. 335

L / W / L **60** cm

15 W - 390 lux - 230 V

Art. **V169** - P. 335

L / W / L **80** cm

20 W - 500 lux - 230 V

Art. **V170** - P. 335

L / W / L **100** cm

25 W - 650 lux - 230 V



Thunder

Faretto orientabile a luce led. Finitura cromo lucido.
 Completo di alimentatore separato /
 Adjustable led spotlight. Chrome finish.
 Complete with separate power supply /
 Spot orientable avec éclairage à led. Finition chrome brillant.
 Avec alimentateur séparé.

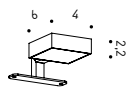

Art. **V832** - P. 336

L / W / L **4** cm

12 V - 2,4 W - 250 lux - 4000 K (luce naturale / natural light / lumière naturelle)



Emy

Faretto a luce led con struttura alluminio e metacrilato trasparente.
 Completo di alimentatore separato /
 Led spotlight with aluminium and transparent methacrylate structure.
 Complete with separate power supply /
 Spot avec éclairage à led avec structure en aluminium et méthacrylate transparent.
 Avec alimentateur séparé.

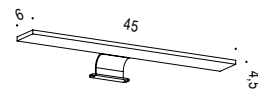

Art. **V610** - P. 335

L / W / L **45** cm

12 V - 4 W - 400 lux - 4000 K (luce naturale / natural light / lumière naturelle)



Miky 35

Faretto a luce led. Finitura brill.
 Alimentatore integrato /
 Led spotlight. Brill finish.
 Built-in power supply /
 Spot avec éclairage à led. Finition Brill.
 Avec alimentateur intégré.

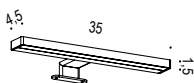

Art. **V116** - P. 335

L / W / L **35** cm

230 V - 4,8 W - 400 lux - 4000 K (luce naturale / natural light / lumière naturelle)



Miky 50

Faretto a luce led. Finitura brill.
 Alimentatore integrato /
 Led spotlight. Brill finish.
 Built-in power supply /
 Spot avec éclairage à led. Finition Brill.
 Avec alimentateur intégré.

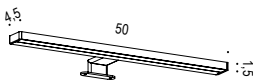

Art. **V916** - P. 335

L / W / L **50** cm

230 V - 7,1 W - 500 lux - 4000 K (luce naturale / natural light / lumière naturelle)



Island

Faretto a luce led con finitura cromo.
Alimentatore integrato /
Led spotlight with chrome finish.
Built-in power supply /
Spot avec éclairage à led avec finition chromo.
Avec alimentateur intégré.

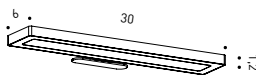

Art. **V830** - P. 336

L / W / L 30 cm

230 V - 8 W - 400 lux - 4000 K (luce naturale / natural light / lumière naturelle)



Flash

Faretto a luce led con finitura acciaio mirror.
Completo di alimentatore separato /
Led spotlight with mirror steel finish.
Complete with separate power supply /
Spot avec éclairage à led, finition acier mirror.
Avec alimentateur séparé.

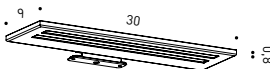

Art. **V818** - P. 337

L / W / L 30 cm

12 V - 5,5 W - 600 lux - 4000 K (luce naturale / natural light / lumière naturelle)



Plano

Faretto a luce led. Finitura metacrilato e Brill.
Alimentatore integrato /
Led spotlight with methacrylate and Brill finish.
Built-in power supply /
Spot avec éclairage à led, finition méthacrylate et Brill.
Avec alimentateur intégré.

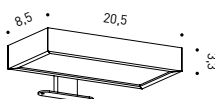

Art. **6923** - P. 336

L / W / L 20,5 cm

230 V - 8 W - 500 lux - 4000 K (luce naturale / natural light / lumière naturelle)



Pill

Faretto a luce led con finitura acciaio mirror e cavo bianco effetto telato.
Completo di alimentatore separato. /
Led spotlight with mirror steel finish and white wove.
Complete with separate power-supply /
Spot avec éclairage à led avec finition acier mirror et cable effet toile bianco.
Avec alimentateur séparé.



Art. **V831** - P. 336

L / W / L 8 cm

12 V - 3,5 W - 300 lux - 4000 K (luce naturale / natural light / lumière naturelle)

Solo per specchiere LIGHT, LIGHT TONDE e WOODLINE /
Only for LIGHT, LIGHT TONDA and WOODLINE mirrors /
Uniquement pour miroirs LIGHT, LIGHT TONDA et WOODLINE.



Saturno

Faretto a luce led. Finitura metacrilato e Brill.
 Completo di alimentatore separato /
 Led spotlight with methacrylate and brill finish.
 Complete with separate power-supply /
 Spot avec éclairage à led, finition méthacrylate et Brill.
 Avec alimentateur séparé.

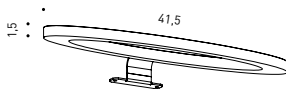

Art. **V056** - P. 336

L / W / L **41,5** cm

12 V - 17 W - 600 lux - 4000 K (luce naturale / natural light / lumière naturelle)



On

Faretto a luce led. Finitura metacrilato e Brill.
 Completo di alimentatore separato /
 Led spotlight with methacrylate and brill finish.
 Complete with separate power-supply /
 Spot avec éclairage à led, finition méthacrylate et Brill.
 Avec alimentateur séparé.

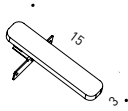

Art. **V054** - P. 336

L / W / L **3** cm

12 V - 3,3 W - 300 lux - 4000 K (luce naturale / natural light / lumière naturelle)



Off

Faretto a luce led. Finitura metacrilato e Brill. Completo di alimentatore separato /
 Led spotlight with methacrylate and brill finish. Complete with separate power-supply /
 Spot avec éclairage à led, finition méthacrylate et Brill. Avec alimentateur séparé.

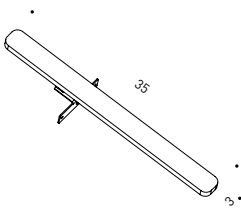

Art. **V055** - P. 336

L / W / L **3** cm

12 V - 8,2 W - 500 lux - 4000 K (luce naturale / natural light / lumière naturelle)



Tiara

Faretto a luce led. Finitura metacrilato e Brill.
 Completo di alimentatore separato /
 Led spotlight with methacrylate and brill finish.
 Complete with separate power-supply /
 Spot avec éclairage à led, finition méthacrylate et Brill.
 Avec alimentateur séparé.

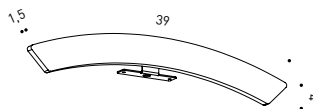

Art. **V057** - P. 337

L / W / L **39** cm

12 V - 8,2 W - 500 lux - 4000 K (luce naturale / natural light / lumière naturelle)

Solo per specchiere LIGHT TONDE Ø 85 e 100 cm /
 Only for LIGHT TONDA mirrors Ø 85 and 100 cm /
 Uniquement pour miroirs LIGHT TONDA Ø 85 et 100 cm.



Bius

Faretto a luce led. Struttura cromo e metacrilato satinato.
Completo di alimentatore separato /
Led spotlight with methacrylate and chrome finish.
Complete with separate power-supply /
Spot avec éclairage à led, finition méthacrylate et chrome.
Avec alimentateur séparé.

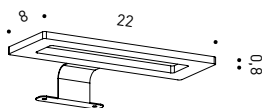

Art. **V833** - P. 337

L / W / L 22 cm

12 V - 12 W - 1000 lux - 4000 K (luce naturale / natural light / lumière naturelle)



Balls

Coppia di faretti a luce led. Sfere in vetro bianco satinato (solo per specchiera TAO) /
Pair of led spotlights. Satin white glass spheres (only for TAO mirrors) /
Paire de spots avec éclairage à led. Sphères en verre blanc satiné (uniquement pour miroirs TAO)

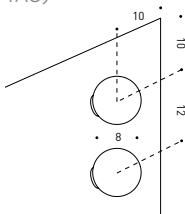

Art. **V032** - P. 337

L / W / L 8 cm

230 V - 2 x 3 W - 390 lux - 4000 K (luce naturale / natural light / lumière naturelle)



Sfera singola

Faretto a luce led, struttura cromo con sfera in vetro trasparente /
Led spotlight, chrome finish with trasparente glass sphere /
Spot avec éclairage à led, finition cromo avec sphère en verre transparent.

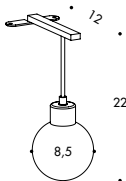

Art. **V024** - P. 337

L / W / L 8,5 cm

230 V - 3 W - 100 lux - 3000 K (luce calda / warm light / lumière chaude)



Apollo

Faretto a luce led, struttura cromo con sfera in vetro trasparente (solo per specchiera AUGUSTO) /
Led spotlight, chrome finish with trasparente glass sphere (for AUGUSTO mirror only) /
Spot avec éclairage à led, finition chrome avec sphère en verre transparent (uniquement pour miroir AUGUSTO).

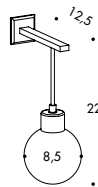

Art. **V029** - P. 337

L / W / L 8,5 cm

230 V - 3 W - 100 lux - 3000 K (luce calda / warm light / lumière chaude)



Sfera doppia

Faretto a luce led, finitura cromo con sfere in vetro trasparente /
 Led spotlight, chrome finish with transparent glass spheres /
 Spot avec éclairage à led, finition chrome avec sphères en verre transparent.

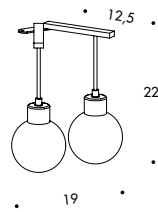

Art. **V025** - P. 337
 L / W / L 19 cm

230 V - 2 x 3 W - 200 lux - 3000 K (luce calda / warm light / lumière chaude)



Satin

Faretto a luce led con struttura cromo o oro e paralume in vetro satinato /
 Led spotlight with chrome or gold structure and lampshade in satin finish glass /
 Spot avec éclairage à led, finition chrome avec sphère en verre transparent.

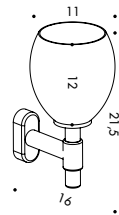

Il faretto Satin può essere montato anche sulla cornice della specchiera Augusto /
 The Satin spotlight can also be fitted onto the frame of the Augusto mirror /
 Le spot Satin peut également être monté sur le cadre du miroir Augusto.

Art. **V026** - P. 338
 L / W / L 11 cm

230 V - 5,3 W - 100 lux - 3000 K (luce calda / warm light / lumière chaude)



Fiaccola bianca

Faretto a luce led, con struttura cromo e cappello bianco /
 Led spotlight, with chrome structure and white top /
 Spot avec éclairage à led avec structure en chrome et chapeau blanc.

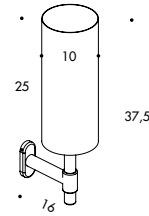

Il faretto Fiaccola può essere montato anche sulla cornice della specchiera Augusto /
 The Fiaccola spotlight can also be fitted onto the frame of the Augusto mirror /
 Le spot Fiaccola peut également être monté sur le cadre du miroir Augusto.

Art. **V021** - P. 338
 L / W / L 10 cm

230 V - 5,3 W - 100 lux - 3000 K (luce calda / warm light / lumière chaude)



Fiaccola nera

Faretto a luce led, con struttura cromo e cappello nero /
 Led spotlight, with chrome structure and black top /
 Spot avec éclairage à led avec structure en chrome et chapeau noir.

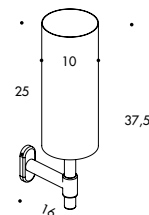

Il faretto Fiaccola può essere montato anche sulla cornice della specchiera Augusto /
 The Fiaccola spotlight can also be fitted onto the frame of the Augusto mirror /
 Le spot Fiaccola peut également être monté sur le cadre du miroir Augusto.

Art. **V021** - P. 338
 L / W / L 10 cm

230 V - 5,3 W - 100 lux - 3000 K (luce calda / warm light / lumière chaude)



Plano a muro

Faretto a luce led. Finitura metacrilato e Brill.
 Alimentatore integrato /
 Led spotlight with methacrylate and brill finish.
 Built-in power supply /
 Spot avec éclairage à led, finition méthacrylate et Brill.
 Avec alimentateur intégré.

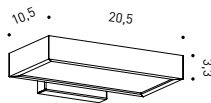

Art. **6924** - P. 338

L / W / L **20,5** cm

230 V - 8 W - 500 lux - 4000 K (luce naturale / natural light / lumière naturelle)

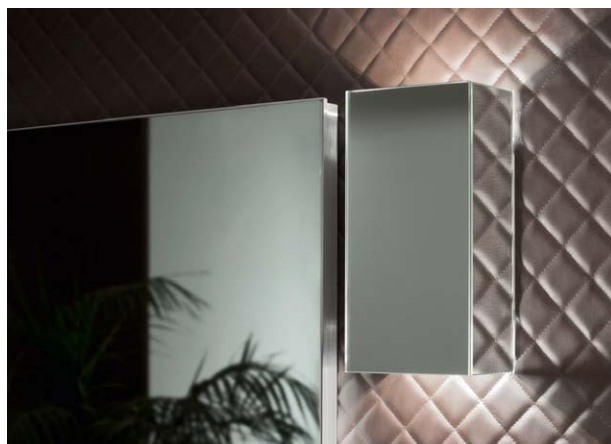

Forma Specchio

Faretto a luce led con struttura rivestita specchio /
 Led spotlight with mirror-coated aluminium structure /
 Spot avec éclairage à led avec structure aluminium revêtu miroir.

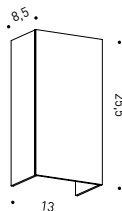

Art. **V061** - P. 338

L / W / L **13** cm

230 V - 2 x 3,5 W - 100 lux - 4000 K (luce naturale / natural light / lumière naturelle)



Forma Colore

Faretto a luce led con struttura alluminio bianco o nero /
 Led spotlight with black or white aluminium structure /
 Spot avec éclairage à led avec structure aluminium bianco ou nero.

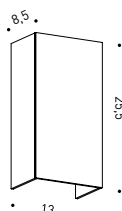

Art. **V062** - P. 338

L / W / L **13** cm

230 V - 2 x 3,5 W - 100 lux - 4000 K (luce naturale / natural light / lumière naturelle)





Ufo

Faretto al luce led, struttura cromo con sfera in vetro trasparente/
Led spotlight, chrome finish with transparent glass sphere /
Spot avec éclairage à led, finition cromo avec sphère en verre transparent.



Art. **V007** - p. 339

L / W / L 12 cm

230 V - 3 W - 100 lux - 3000 K (luce calda / warm light / lumière chaude)



Piro

Faretto a luce led con stelo in ottone verniciato bianco opaco H 40 cm.
Cavo in acciaio L 180 cm e placca H 3 x ø 13 cm /
Led spotlight with brass stem painted matt white H 40 cm.
Steel cable L 180 and plate H 3 x ø 13 cm /
Spot avec éclairage à led avec tige en laiton peint blanc mat H 40 cm.
Câble en acier L 180 cm et plaque H 3 x ø 13 cm.

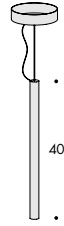

Art. **V608** - p. 339

L / W / L 2,5 cm

230 V - 2 W - 1000 lux - 4000 K (luce naturale / natural light / lumière naturelle)





ACCESSORIES

ACCESSOIRES

ACCESSORI

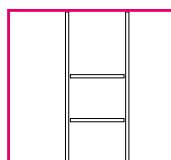
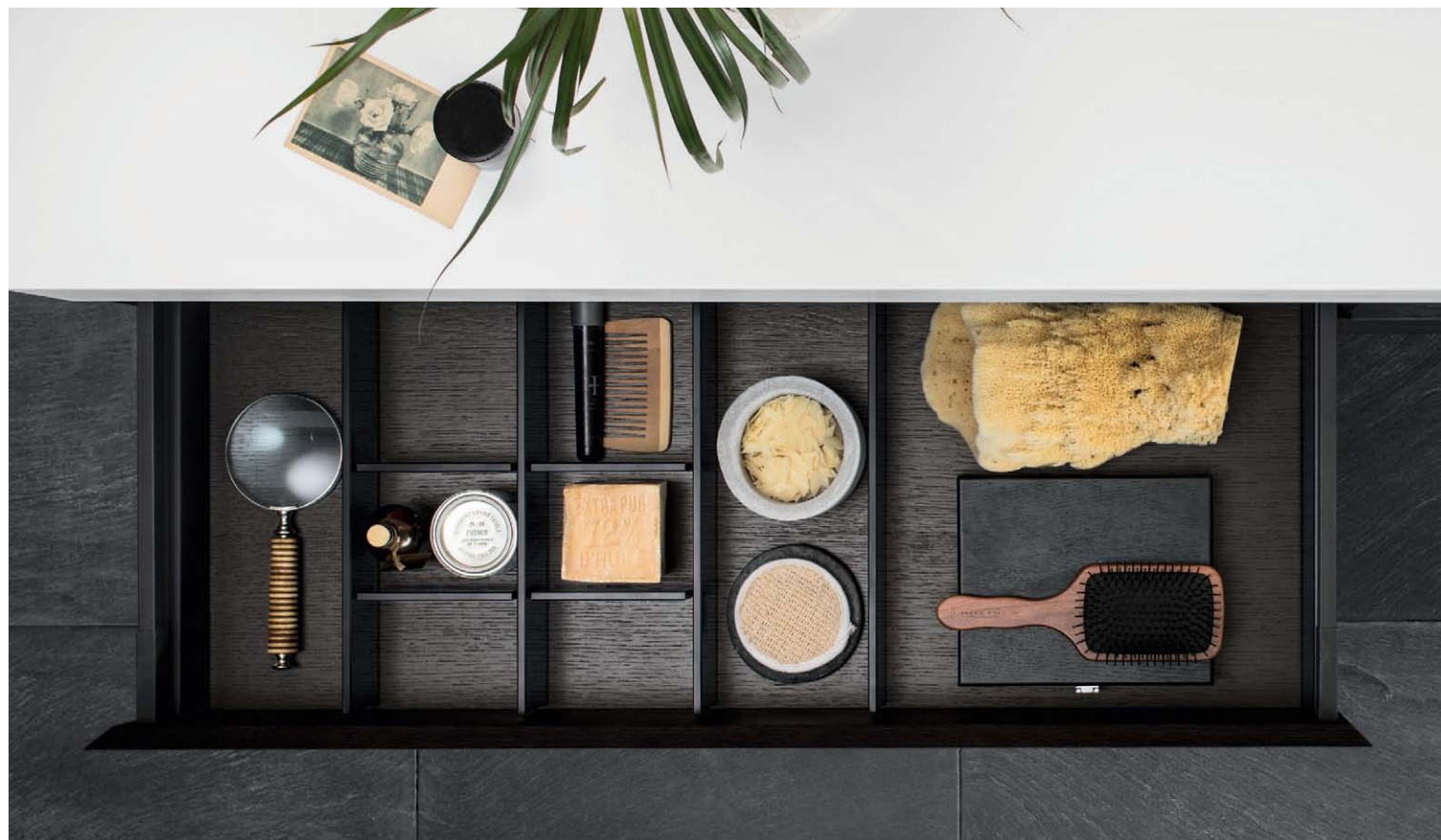

Art. **V387**
P. 341
Cassetto
L 50 x P 50 cm

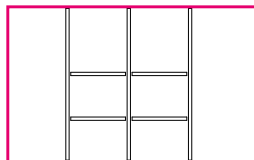

Art. **V389**
P. 341
Cassetto
L 70 x P 50 cm

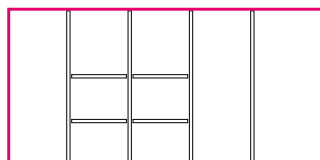

Art. **V390**
P. 341
Cassetto
L 85 x P 50 cm

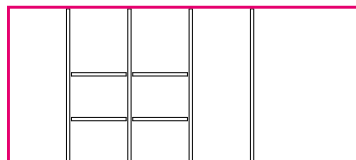

Art. **V391**
P. 341
Cassetto
L 95 x P 50 cm



Art. **V392**
P. 341
Cassetto
L 105 x P 50 cm

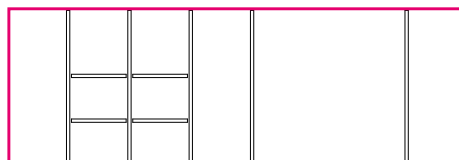

Art. **V393**
P. 341
Cassetto
L 120 x P 50 cm

Attrezzatura interna scura

Dark internal accessories

Équipement interne foncé

Attrezzatura interna per cassetti CODE e ABSOLUTE. Fondo in legno scuro, con divisori in vetro Dark Grey sp. 8 mm /
Internal accessories for CODE and ABSOLUTE drawers. Dark wood bottom, with Dark Grey glass partitions, 8 mm thick /
Équipement interne pour tiroirs CODE et ABSOLUTE. Fond en bois foncé. avec séparations en verre Dark Grey ép. 8 mm.

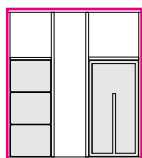

Art. V223
P. 340
Cassetto
L 50 x P 50 cm

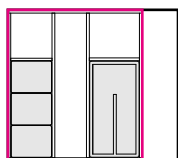

Art. V224
P. 340
Cassetto
L 60 x P 50 cm

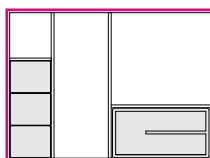

Art. V225
P. 340
Cassetto
L 70 x P 50 cm

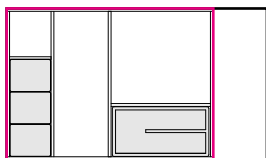

Art. V226
P. 340
Cassetto
L 85 x P 50 cm

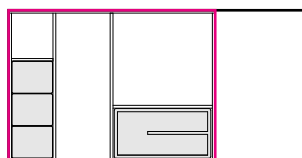

Art. V227
P. 340
Cassetto
L 95 x P 50 cm

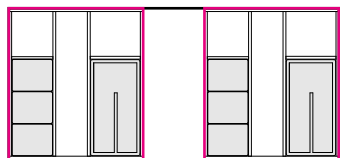

Art. V228
P. 340
Cassetto
L 105 x P 50 cm

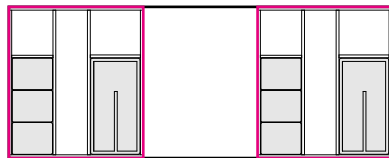

Art. V229
P. 340
Cassetto
L 120 x P 50 cm

Attrezzatura interna in legno

Internal accessories
in wood

Équipement interne en bois

Divisori per cassettoni P 50 cm in rovere bianco. Completo di tappetino gommato, scatoline e vaschetta portaoggetti estraibile in plastica. / Organizers for drawers W 50 in white oak. Rubber mat, plastic boxes and plastic glove box included. / Séparateurs pour les tiroirs P 50 cm en chêne blanc. Avec tapis en caoutchouc, boîtes extractibles et 1 cuvette en plastique.



Porta phon

Porta phon da fissare all'interno dell'anta delle basi portalavabo (senza ripiano interno) /
Hairdryer holder to be attached inside the door of the washbasin units (no internal shelf) /
Porte sèche-cheveux à fixer l'intérieur de la porte de l'élément sous lavabo (sans tablette interne).

Art. **W016** - P. 342



Vaschetta portaoggetti

Vaschetta portaoggetti da fissare all'interno dell'anta min. L 47,5 cm delle basi portalavabo. /
Tray to be attached inside the door, min. 47,5 cm, of the washbasin unit /
Cuvette porte-objets à fixer à l'intérieur de la porte min. L 47,5 cm de l'élément sous lavabo.

Art. **W017** - P. 342
L 34 x H 6,5 x P 10 cm
W 34 x H 6,5 x D 10 cm
L 34 x H 6,5 x P 10 cm



Vaschetta portaoggetti

Vaschetta portaoggetti da fissare all'interno dell'anta min. L 35 cm. /
Tray to be attached inside the door, min. 35 cm /
Cuvette porte-objets à fixer à l'intérieur de la porte min. L 35 cm.

Art. **W018** - P. 342
L 26 x H 8 x P 10 cm
W 26 x H 8 x D 10 cm
L 26 x H 8 x P 10 cm





Portatubo

Porta accessori + tubo aspirapolvere da fissare all'interno dell'anta delle colonne attrezzate min. L 50 cm /
 Accessory holder + Hoover pipe to be attached inside the door of the fitted tall units, min. W 50 cm /
 Porte-accessoires + tuyau aspirateur à fixer à l'intérieur de la porte des colonnes équipées min. L 50 cm.

Art. **W019** - P. 342

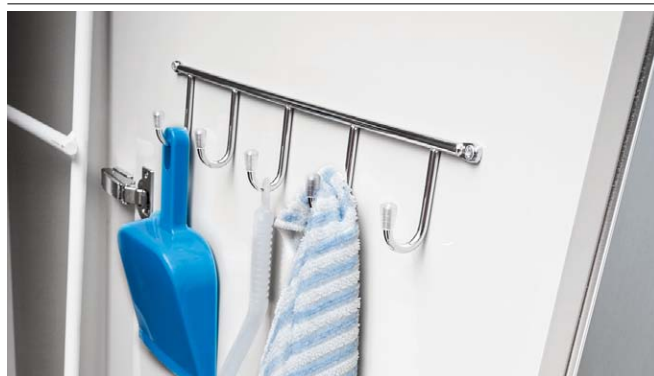

Ganci portascopo

Ganci portascopo L 35 cm da fissare all'interno dell'anta delle colonne min. L 50 cm /
 Brush hooks W 35 cm to be attached inside the door of the tall units, min. W 50 cm /
 Crochets porte-balais L 35 cm à fixer à l'intérieur de la porte des colonnes min. L 50 cm.

Art. **W020** - P. 342



Cestelli / Baskets / Paniers

Cestello portabiancheria a ribalta cromato. Apertura massima ribalta 33 cm /
 Laundry basket chrome, tilt-out. Maximum opening of tilt-out door 33 cm /
 Panier à linge abattant chromé. Ouverture maximale abattante 33 cm.

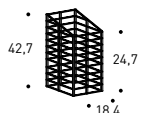

Art. **5865** - P. 342

Per basi L 25 x P 37 cm con anta H 49 - 61,2 - 73,4 cm
 To use in base units W 25 x D 37 cm with door H 49 - 61,2 - 73,4 cm /
 À insérer sur tous les éléments bas L 25 x P 37 avec porte H 49 - 61,2 - 73,4 cm

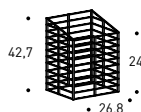

Art. **5863** - P. 342

Per basi L 35 x P 37 cm con anta H 49 - 61,2 - 73,4 cm
 To use in base units W 35 x D 37 cm with door H 49 - 61,2 - 73,4 cm /
 À insérer sur tous les éléments bas L 35 x P 37 avec porte H 49 - 61,2 - 73,4 cm



Art. **5855** - P. 342

Per basi L 50 x P 37/50 cm con anta H 49 cm
 To use in base units W 50 x D 37/50 cm with door H 49 cm /
 À insérer sur tous les éléments bas L 50 x P 37/50 avec porte H 49 cm

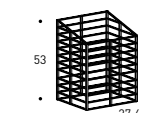

Art. **5873** - P. 342

Per basi L 50 x P 50/62/67,5 cm con anta H 73,4 cm /
 To use in base units W 50 x D 50/62/67,5 cm with door H 73,4 cm /
 À insérer sur tous les éléments bas L 50 x P 50/62/67,5 avec porte H 73,4 cm

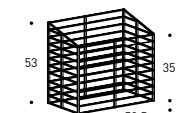

Art. **5866** - P. 342

Per basi L 60 x P 50/62/67,5 cm con anta H 73,4 cm /
 To use in base units W 50 x D 50/62/67,5 cm with door H 73,4 cm /
 À insérer sur tous les éléments bas L 50 x P 50/62/67,5 avec porte H 73,4 cm





Mafalda

Portasalviette Mafalda applicabile sotto a piani H 3,6, 8, 12,2. Finitura brill o nero /
Mafalda towel rail, to be used under tops H 3,6, 8, 12,2. Finishes: brill or black /
Porte-serviettes Mafalda, applicable sous plans H 3,6, 8, 12,2. Finitions Brill ou noir.

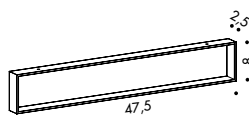

BRILL:

Art. **A325** - P. 344
L / W / L 47,5 cm

NERO / BLACK / NOIR:

Art. **A299** - P. 344
L / W / L 47,5 cm



Maffy

Portasalviette Maffy applicabile sul fianco delle basi P 37, 50, 62 e 67,5 cm. Finitura brill o nero /
Maffy towel rail, to be used on the side of base units D 37, 50, 62 e 67,5 cm. Finishes: brill or black /
Porte-serviettes Maffy, applicable sur le côté des éléments bas P 37, 50, 62 et 67,5 cm. Finitions Brill ou noir

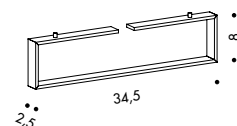

BRILL:

Art. **A211** - P. 344
L / W / L 34,5 cm

NERO / BLACK / NOIR:

Art. **A300** - P. 344
L / W / L 34,5 cm



Linus

Portasalviette Linus per piani H 3,6, 8 o 12,2 cm. Finitura brill o nero /
Linus towel rail, for tops H 3,6, 8 or 12,2 cm. Finishes: brill or black /
Porte-serviettes Linus, pour plans H 3,6, 8 ou 12,2 cm. Finitions Brill ou noir.

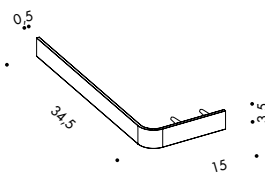

BRILL:

Art. **A432** - P. 344
L / W / L 34,5 cm

NERO / BLACK / NOIR:

Art. **A298** - P. 344
L / W / L 34,5 cm

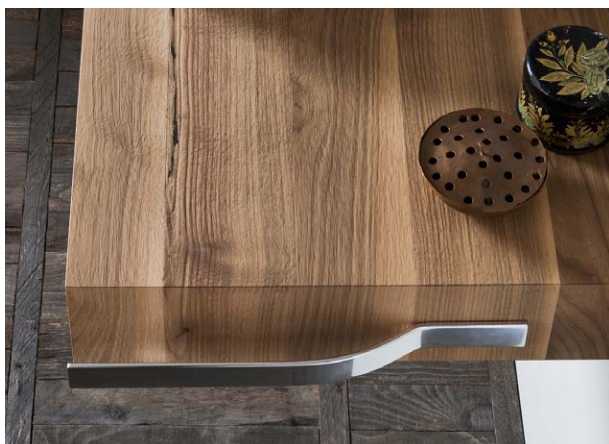

Snoopy

Portasalviette Snoopy per mobili P 37 e 50 cm. Finitura brill o nero /
Snoopy towel rail, for furniture D 37 or 50 cm. Finishes: brill or black /
Porte-serviettes Snoopy, pour meuble P 37 ou 50 cm. Finitions Brill ou noir.

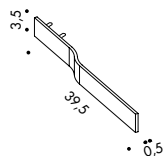

BRILL:

Art. **A431** - P. 344
L / W / L 39,5 cm

NERO / BLACK / NOIR:

Art. **A297** - P. 344
L / W / L 39,5 cm



Fast curvo

Portasalviette Fast per fianco di tamponamento curvo. Finitura brill /
Fast towel rail for curved infill side. Finish: brill. /
Porte-serviettes Fast pour élément arrondi. Finition brill.

Per fianchi di tamponamento art. V808 /
For curved infill side item V808 /
Pour élément arrondi art. V808.

Art. **A210** - P. 344



Fast

Maniglione portasalviette Fast. Finitura brill /
Fast large handle towel rail. Finish: brill. /
Grande poignée porte-serviettes Fast. Finition brill.

Per elementi L 50 e 60 cm /
For elements W 50 and 60 cm /
Pour élément L 50 et 60 cm.

Art. **A205** - P. 344

Per elementi L 70 cm /
For elements W 70 cm /
Pour élément L 70 cm.

Art. **A207** - P. 344

Per elementi L 85 cm /
For elements W 85 cm /
Pour élément L 85 cm.

Art. **A208** - P. 344

Per elementi L 95 e 105 cm /
For elements W 95 and 105 cm /
Pour élément L 95 et 105 cm.

Art. **A209** - P. 344

Per elementi L 120 cm /
For elements W 120 cm /
Pour élément L 120 cm.

Art. **A212** - P. 344



Portasalviette tubolare

Portasalviette in tubolare di alluminio sp. 1,5 cm nelle finiture Rodio e Nero con piedini regolabili /
Aluminium tube towel rail, 1,5 cm thick, in Rodio and Nero finishes with adjustable feet /
Porte-serviettes en tube d'aluminium ép. 1,5 cm dans les finitions Rodio et Nero avec pieds réglables.

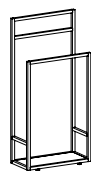

18 : 38

Art. **AT15** - P. 294
L / W / L 38 cm



Scaletta

Elemento a scaletta in tondino di metallo bianco opaco /
Ladder unit made from matt white metal bar /
Élément en échelle en tube de métal blanc mat.



Art. **V305** - P. 292
L / W / L 49 cm



Sgabello

Sgabello in tubolare di alluminio sp. 1,5 cm, finitura Nero o Rodio, con top in legno, Laminam o gres /
Aluminium tube stool, 1,5 thick, in the Rodio and Nero finishes with wooden, Laminam or Gres top /
Tabouret en tube d'aluminium ép. 1,5 cm dans les finitions Rodio et Nero, avec plan de toilette en bois, Laminam ou gres.

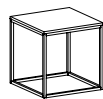

Art. **AT11** - P. 344
L / W / L 40 cm



Sgabello con cuscino

Sgabello in tubolare di alluminio sp. 1,5 cm, finitura Nero o Rodio, con cuscino in ecopelle H 7 cm /
Aluminium tube stool, 1,5 thick, in the Rodio and Nero finishes with eco-leather cushion H 7 cm /
Tabouret en tube d'aluminium ép. 1,5 cm dans les finitions Rodio et Nero, avec coussin en éco-cuir H 7 cm.

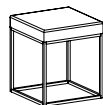

Art. **AT12** - P. 344
L / W / L 40 cm



design

Ufficio Tecnico Arbi

graphic design

Ufficio Tecnico Arbi

photography

Photografica

Contratti Company

Auber

color separation

Lucegroup.it

printed in italy

Grafiche GFP

Febbraio 2019

ARBI
BATHROOM

Arbi Arredobagno srl

Viale Lino Zanussi, 34/A
33070 Maron di Brugnera
Pordenone - Italy
Tel. +39 0434 624822
Fax +39 0434 624991
www.arbiarredobagno.it

**ATMA**
INDUSTRIE DEL MOBILE

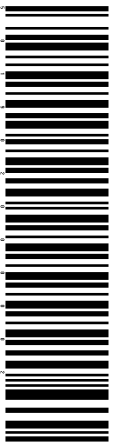

ARBI
BATHROOM

Arbi Arredobagno srl
Viale Lino Zanussi, 34/A
33070 Maron di Brugnera (PN)
Tel. +39 0434 624822
www.arbiarredobagno.it